

Strangkühlkörper

Extruded heatsinks

Dissipateurs extrudés

SK 453

37,5 50 75 100 1000 mm

SSR 1

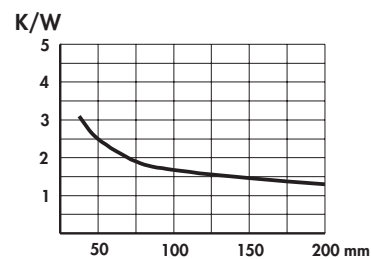
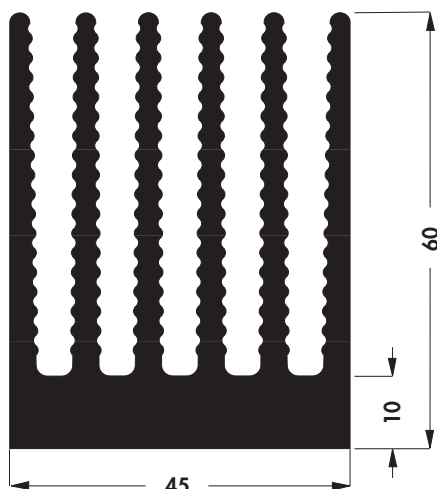

SK 455

75 1000 mm

SSR 1

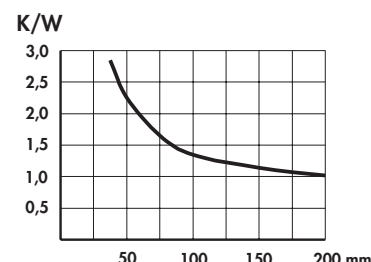
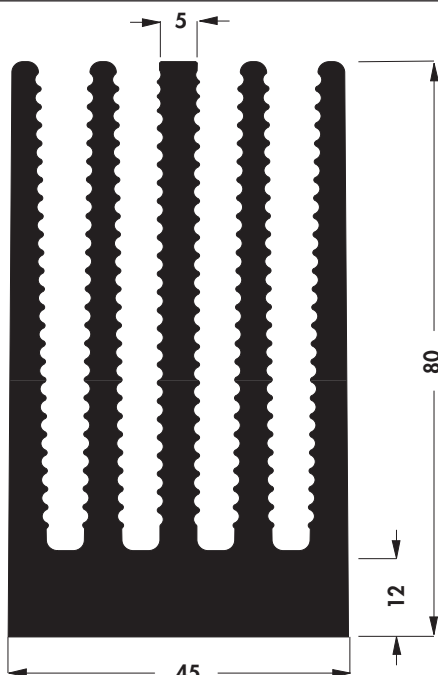

Strangkühlkörper

Extruded heatsinks

Dissipateurs extrudés

SK 100

↔ 37,5 50 75 100 150 1000 mm

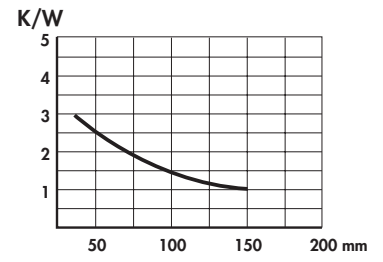
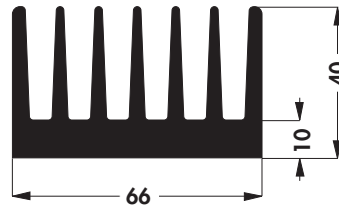

SK 464

↔ 50 75 100 150 1000 mm

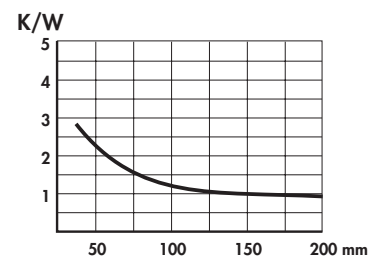
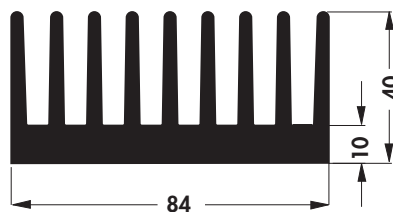

Strangkühlkörper

Extruded heatsinks

Dissipateurs extrudés

SK 408

↔ 50 75 100 150 1000 mm

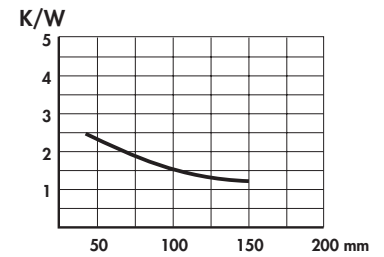
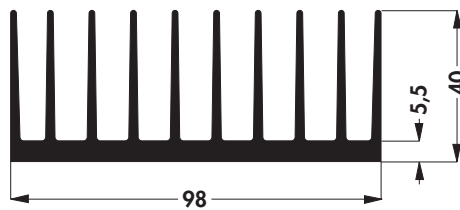

Strangkühlkörper	Extruded heatsinks	Dissipateurs extrudés
------------------	--------------------	-----------------------

SK 92

↔ 50 75 100 150 1000 mm

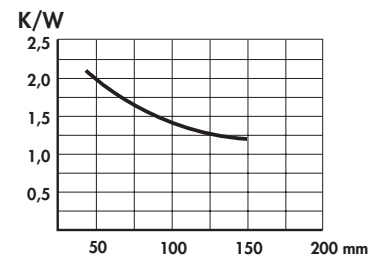
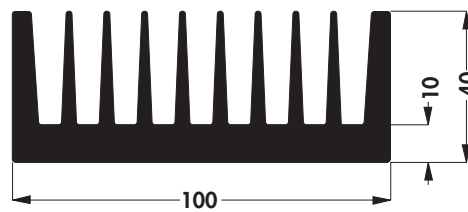

SK 433

↔ 37,5 50 75 1000 mm

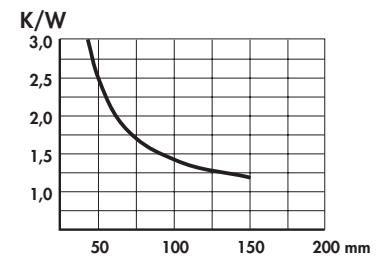
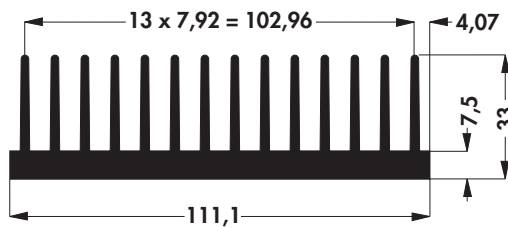

SK 442

↔ 50 75 100 150 1000 mm

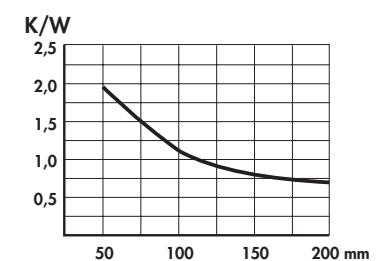
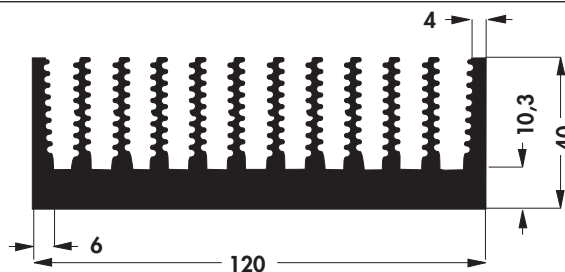

Strangkühlkörper

Extruded heatsinks

Dissipateurs extrudés

SK 410

↔ 37,5 50 75 100 150 1000 mm

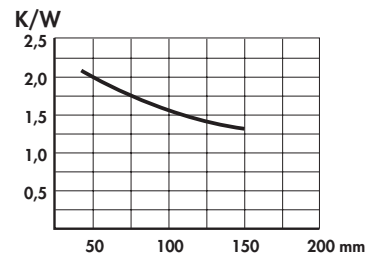
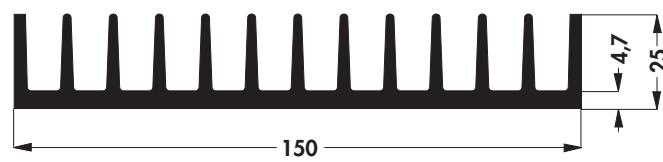

Strangkühlkörper

Extruded heatsinks

Dissipateurs extrudés

SK 417

↔ 75 100 150 1000 mm

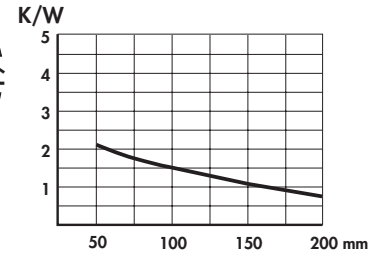
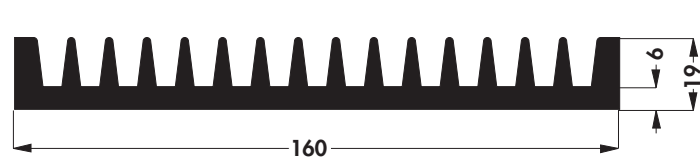

Strangkühlkörper

Extruded heatsinks

Dissipateurs extrudés

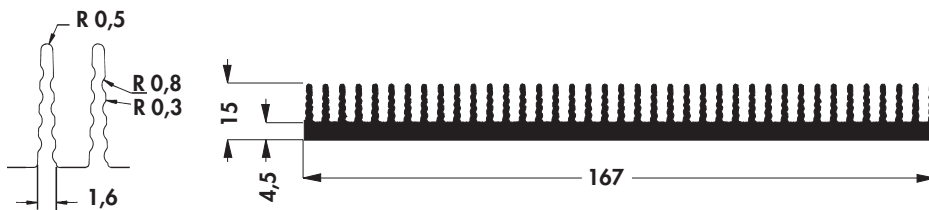

SK 421

50 75 100 150 200 1000 mm

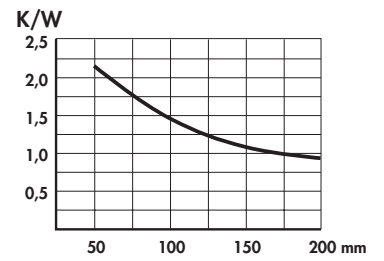

Strangkühlkörper

Extruded heatsinks

Dissipateurs extrudés

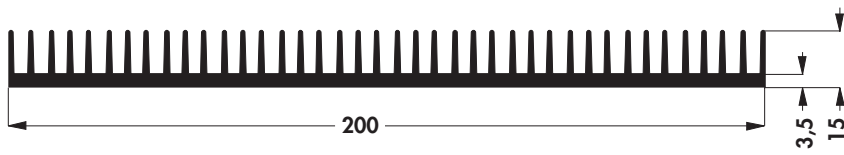

SK 166

 1000 mm

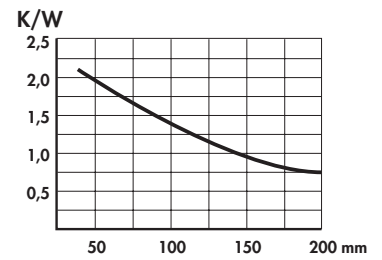

Strangkühlkörper

Extruded heatsinks

Dissipateurs extrudés

SK 401

↔ 100 1000 mm

TO 3 CB

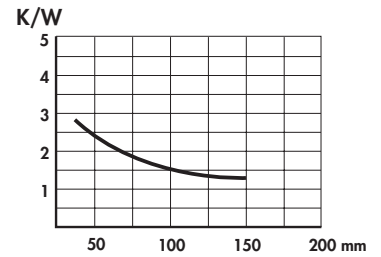
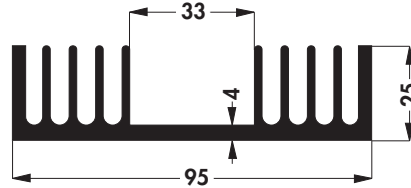

SK 04

↔ 37,5 50 75 100 1000 mm

TO 3 CB SSR1 SSR2

mit Führungsnuten für Abdeckplatten oder Platinen

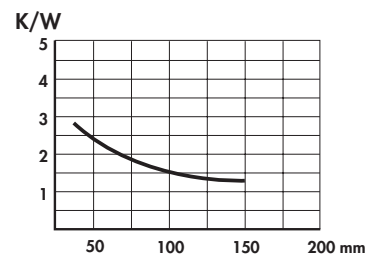
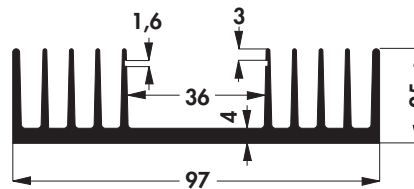

with slots for cover plates or P.C.B.'s.

avec rainures pour tôles de protection ou cartes imprimées

SK 72

↔ 37,5 50 75 100 1000 mm

TO 3 CB

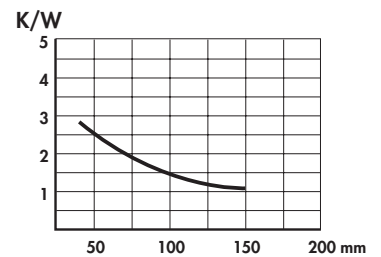
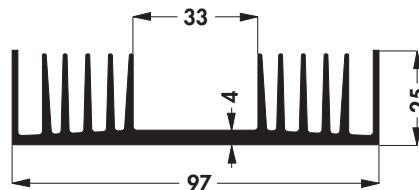

SK 403

↔ 75 1000 mm

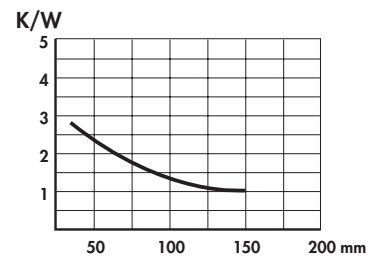
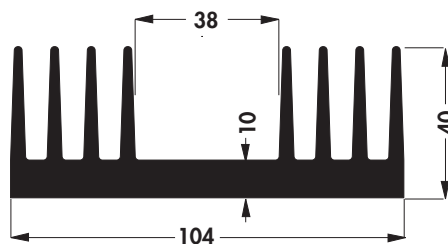

Strangkühlkörper

Extruded heatsinks

Dissipateurs extrudés

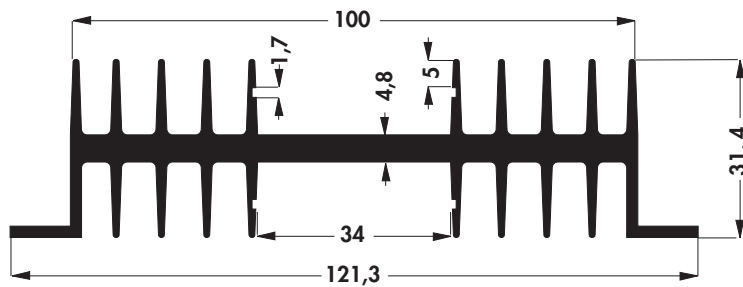

SK 39

75 100 1000 mm

TO 3 CB

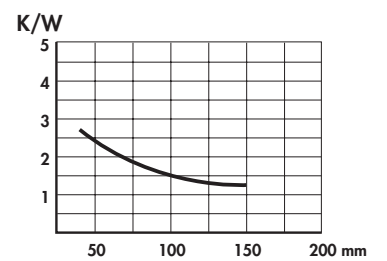

Strangkühlkörper

Extruded heatsinks

Dissipateurs extrudés



SK 14

50 75 100 mm

TO 3 CB

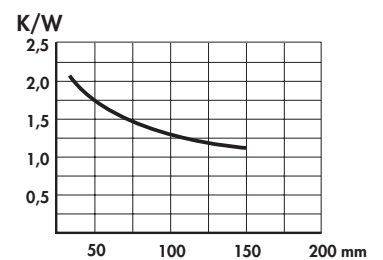
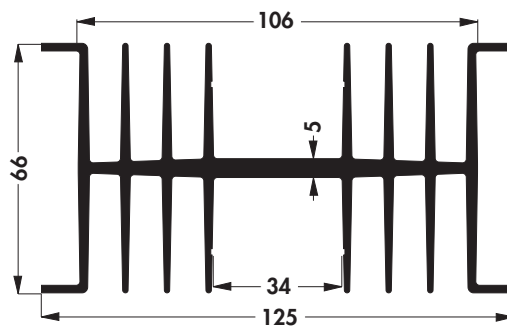

Strangkühlkörper

Extruded heatsinks

Dissipateurs extrudés

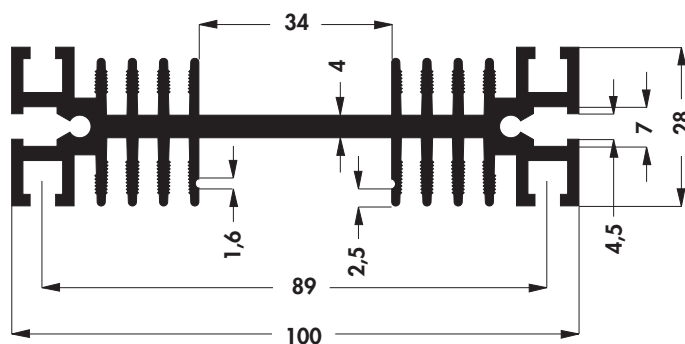

SK 20

↔ 37,5 75 100 1000 mm

⌀ TO 3 ⌀ CB

mit Führungsnuten für Abdeckplatten oder Platinen

Montageteil IS 5, IS 8 → E 26

with slots for cover plates or P.C.B.'s.

Mounting part IS 5, IS 8 → E 26

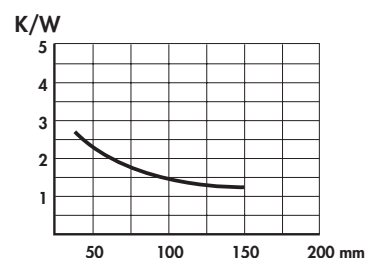

avec rainures pour tôles de protection ou cartes imprimées.

Pièce de fixation IS 5, IS 8 → E 26

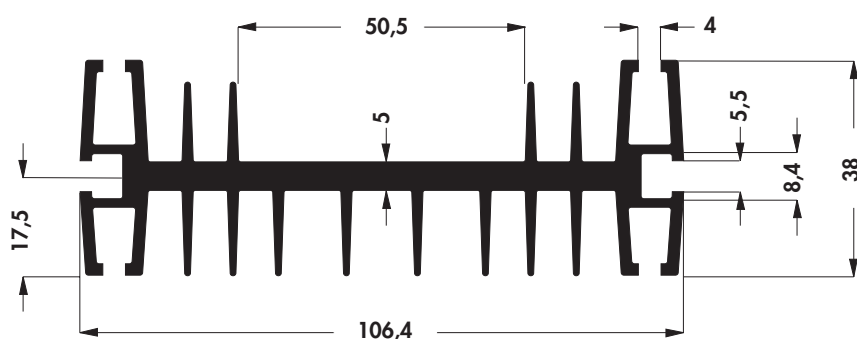

SK 184

↔ 100 1000 mm

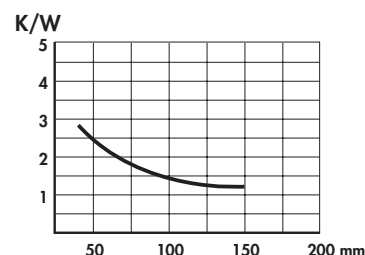

Strangkühlkörper

Extruded heatsinks

Dissipateurs extrudés

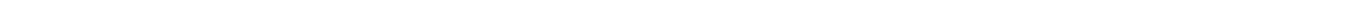

SK 84

50 100 150 1000 mm

TO 3

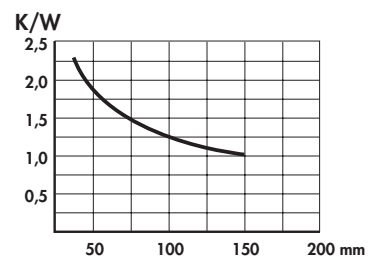
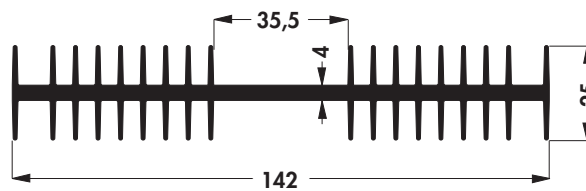

Strangkühlkörper

Extruded heatsinks

Dissipateurs extrudés

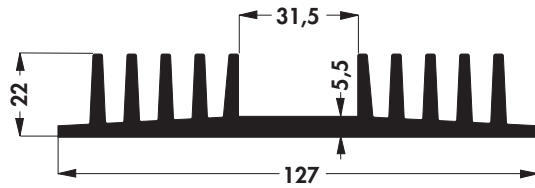

SK 74

37,5 100 1000 mm

TO 3 CB

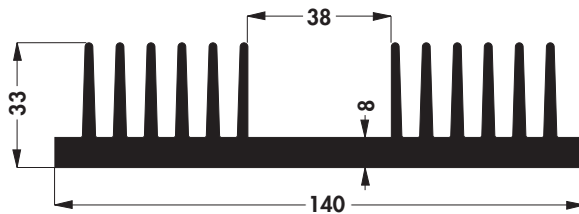
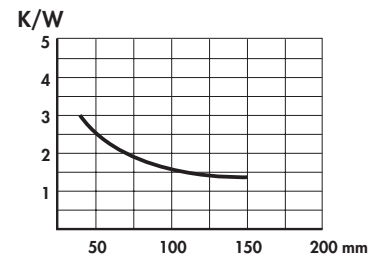

SK 124

50 75 100 150 1000 mm

TO 3

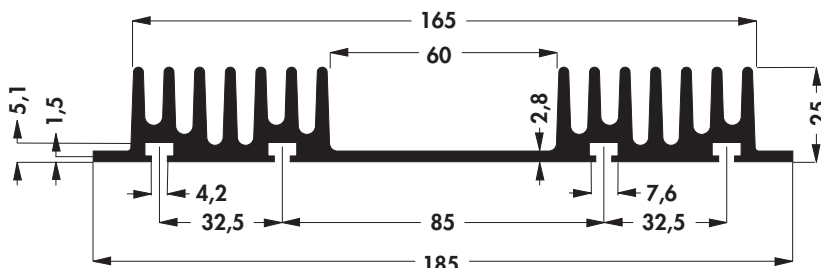
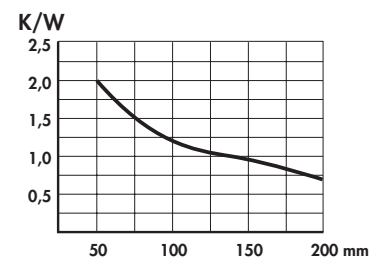

SK 195

75 100 mm

TO 3 CB

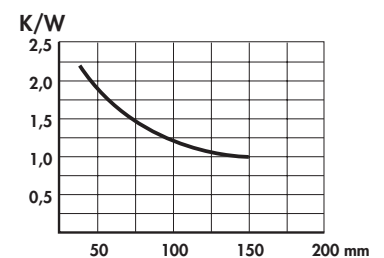

Strangkühlkörper

Extruded heatsinks

Dissipateurs extrudés

SK 08

↔ 37,5 50 75 100 1000 mm

⊙ TO 3 ⊙ CB

mit Führungsnuten für Abdeckplatten
oder Platinen

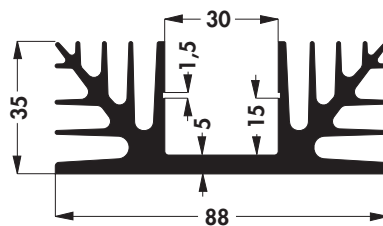

with slots for cover plates or P.C.B.'s.

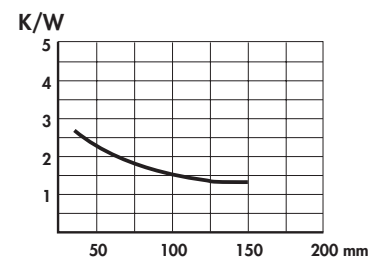

avec rainures pour tôles de protection ou
cartes imprimées

Strangkühlkörper

Extruded heatsinks

Dissipateurs extrudés

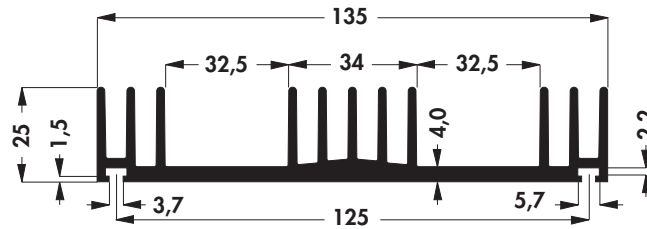

SK 60

┆ 50 75 100 1000 mm

⌀ 2 x TO 3 ⌀ 2 x CB

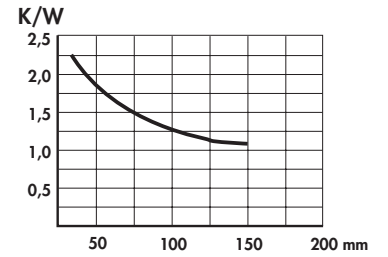

Strangkühlkörper

Extruded heatsinks

Dissipateurs extrudés

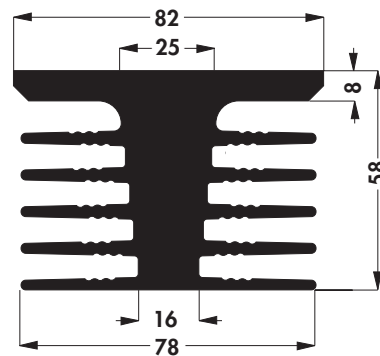

SK 176

75 100 150 1000 mm

SSR 1

SSR 2

SSR 3

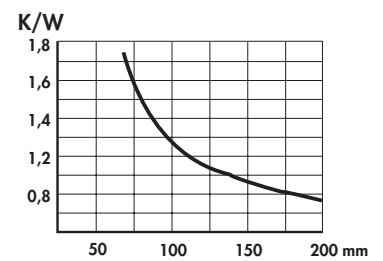

Spezialkühlkörper

Special heatsinks

Dissipateurs spéciaux

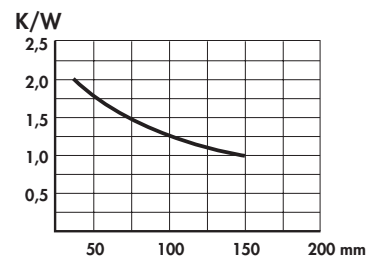
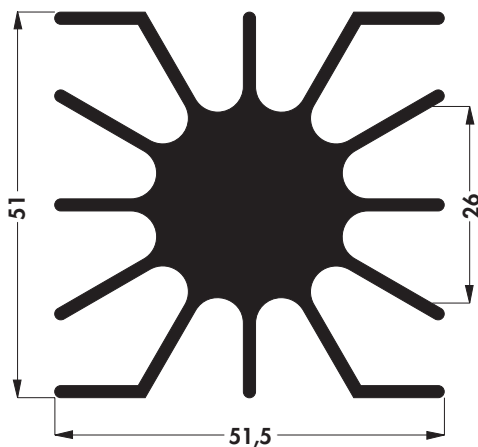

SK 46

↔ 50 75 1000 mm

Gewinde, Durchgangslöcher und Befestigungsschlitze nach Ihren Angaben.

Threads, through holes and fixing slots to your request.

Taraudages, trous débouchants et fentes de fixation suivant votre spécification.

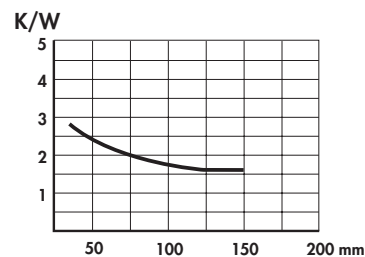
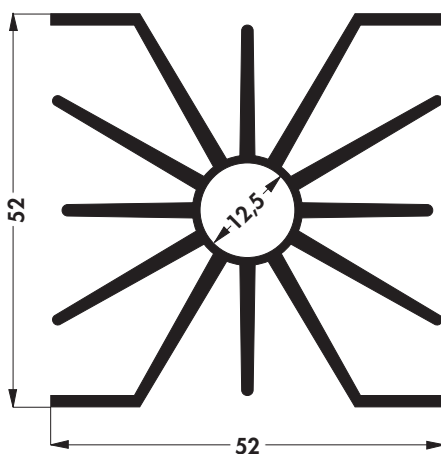

SK 11

↔ 1000 mm

Gewinde, Durchgangslöcher und Befestigungsschlitze nach Ihren Angaben.

Threads, through holes and fixing slots to your request.

Taraudages, trous débouchants et fentes de fixation suivant votre spécification.

Spezialkühlkörper

Special heatsinks

Dissipateurs spéciaux

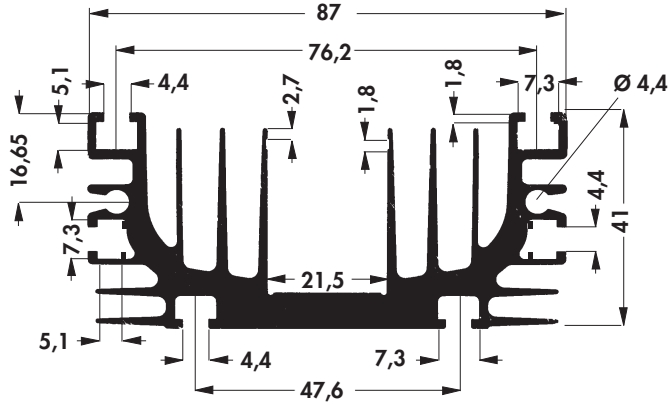

SK 432

 100 1000 mm

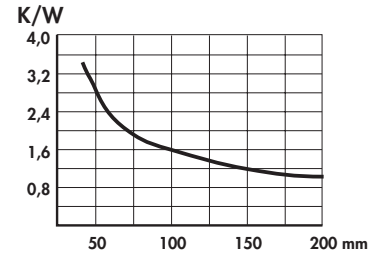

Spezialkühlkörper

Special heatsinks

Dissipateurs spéciaux

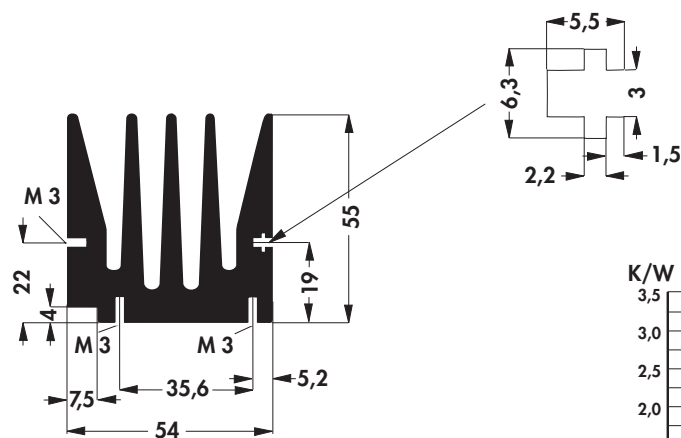

SK 429

↔ 37,5 50 75 100 1000 mm

passende Schrauben M 3 → A 76

matching screws M 3 → A 76

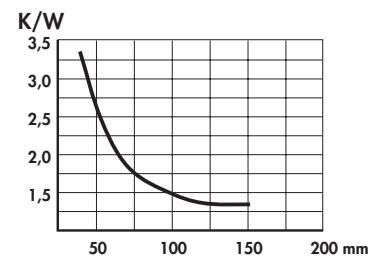

vis convenables → A 76

Bitte beachten:
Profilgepresste Gewinde: → A 7-2.

Please note:
Profile threads: → A 7-2.

Veillez considérer:
Taraudages extrudés: → A 7-2.

Spezialkühlkörper

Special heatsinks

Dissipateurs spéciaux

SK 50

↔ 75 1000 mm

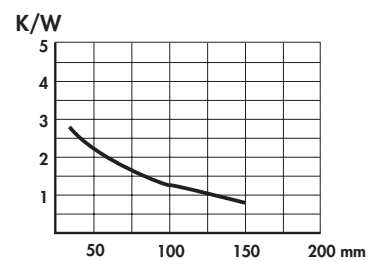
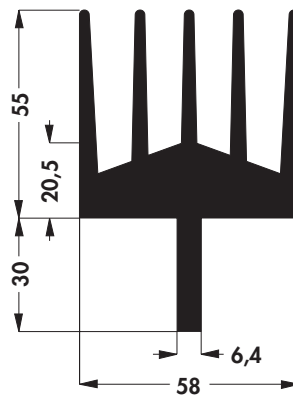

Strangkühlkörper

Extruded heatsinks

Dissipateurs extrudés

SK 172

50 75 100 150 1000 mm

SSR 1 SSR 2

