

Strangkühlkörper

Extruded heatsinks

Dissipateurs extrudés

SK 467

↔ 37,5 50 75 100 1000 mm
SSR 1

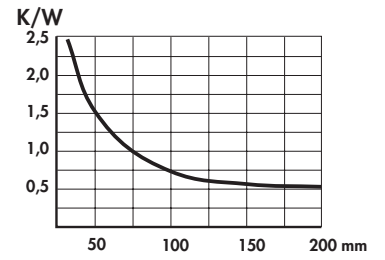
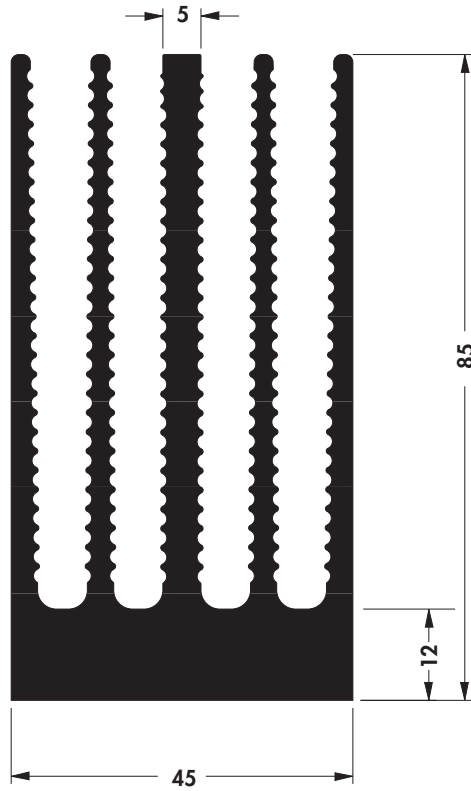

Strangkühlkörper

Extruded heatsinks

Dissipateurs extrudés

SK 135

↔ 50 75 100 1000 mm

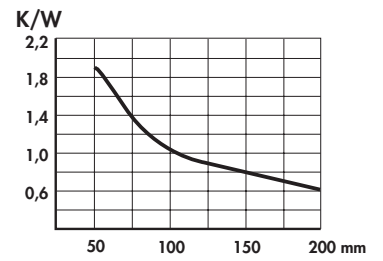
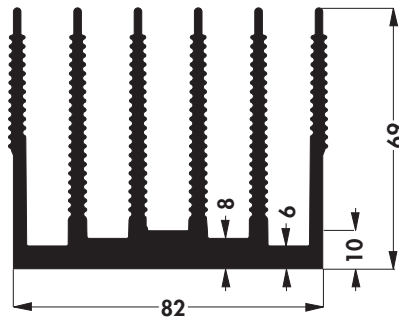



Strangkühlkörper

Extruded heatsinks

Dissipateurs extrudés

SK 507

 37,5 50 75 100 1000 mm
 SSR 1  SSR 2

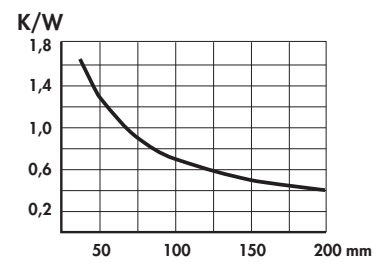
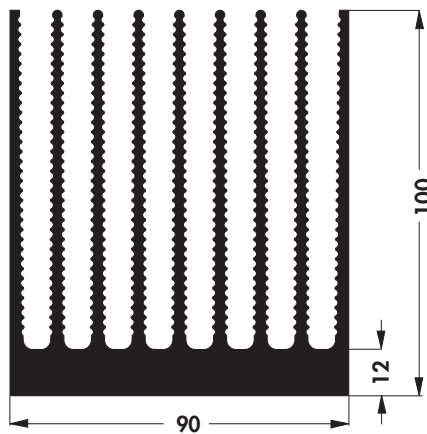

Strangkühlkörper	Extruded heatsinks	Dissipateurs extrudés
-------------------------	---------------------------	------------------------------

SK 121

↔ 75 100 150 1000 mm

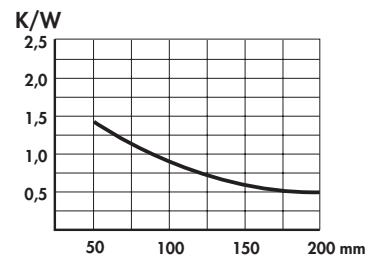
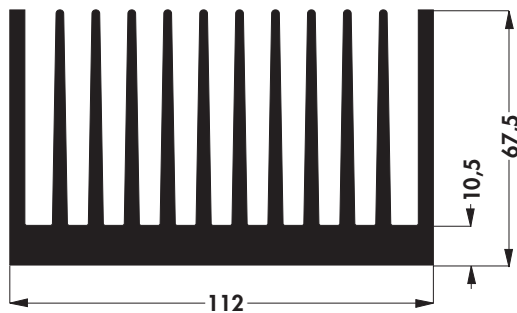

SK 411

↔ 50 75 100 150 1000 mm

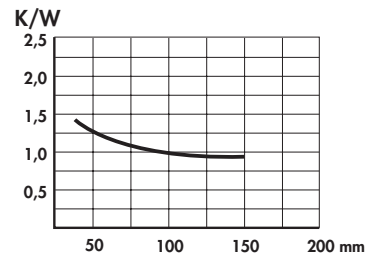
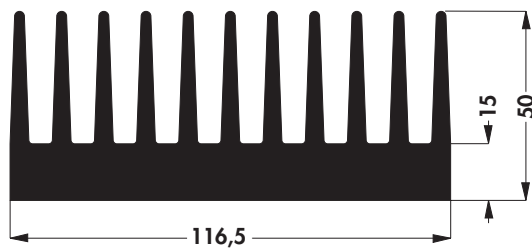

Strangkühlkörper

Extruded heatsinks

Dissipateurs extrudés

SK 463

↔ 50 75 100 150 1000 mm

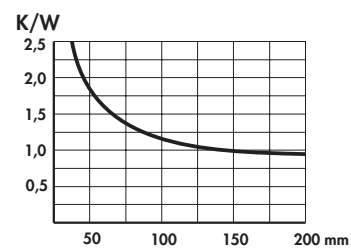
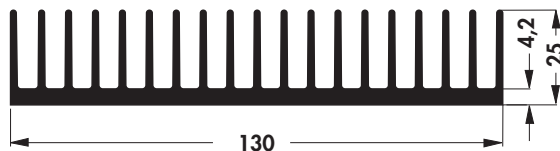

SK 413

↔ 100 150 1000 mm

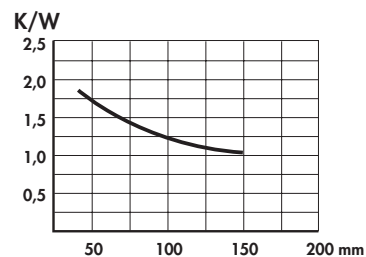
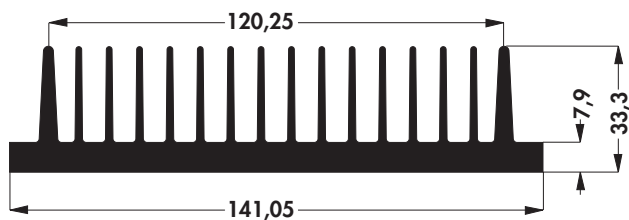

SK 132

↔ 37,5 50 75 100 150 1000 mm

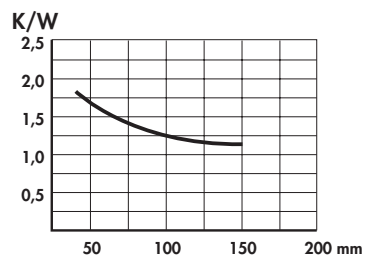
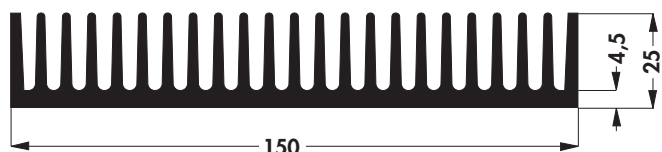

SK 58

↔ 50 75 100 150 1000 mm

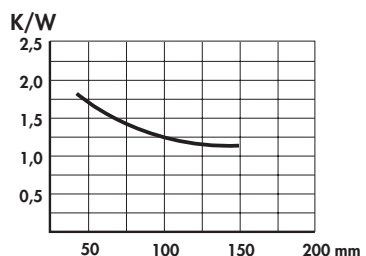
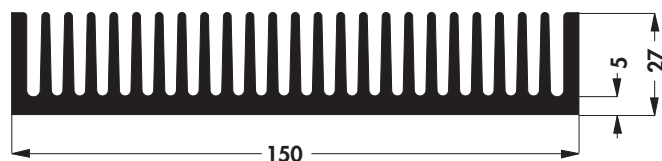

Strangkühlkörper

Extruded heatsinks

Dissipateurs extrudés

SK 133

↔ 50 75 100 1000 mm

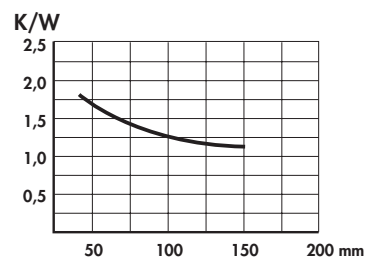
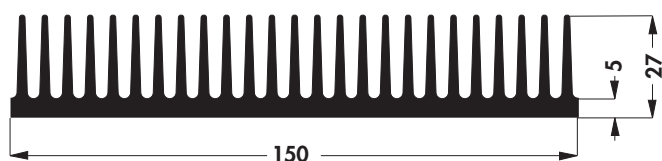

SK 120

↔ 50 75 100 150 1000 mm

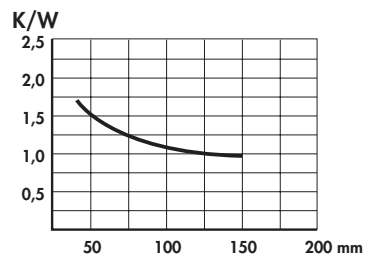
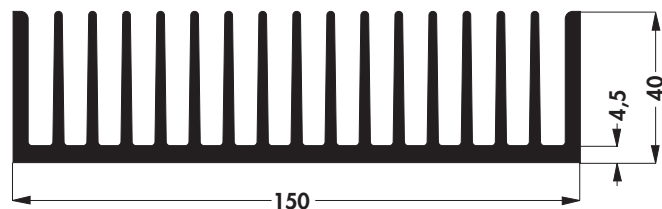

Strangkühlkörper

Extruded heatsinks

Dissipateurs extrudés

SK 85

↔ 37,5 50 75 100 150 1000 mm

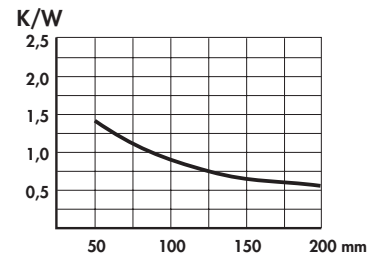
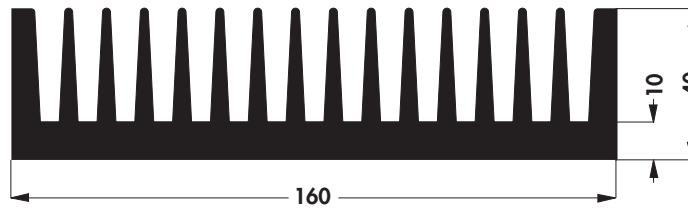

Strangkühlkörper	Extruded heatsinks	Dissipateurs extrudés
------------------	--------------------	-----------------------

SK 119

↔ 50 75 100 150 1000 mm

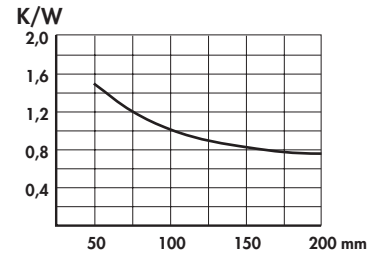
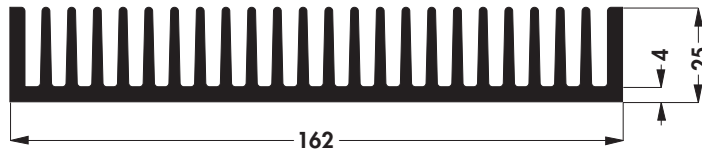

SK 412

↔ 50 75 100 150 1000 mm

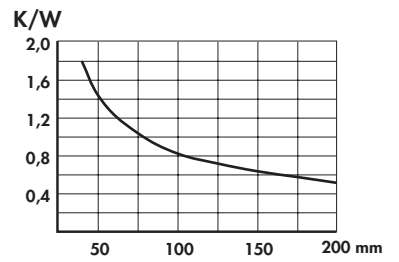
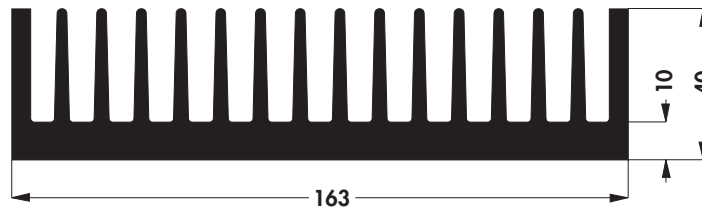

Strangkühlkörper

Extruded heatsinks

Dissipateurs extrudés

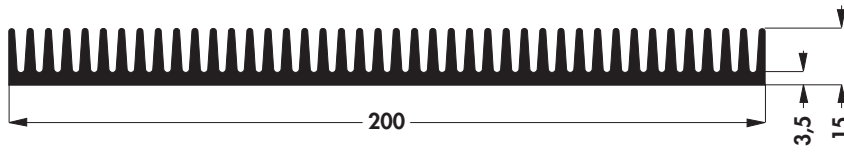

SK 136

↔ 75 100 150 1000 mm

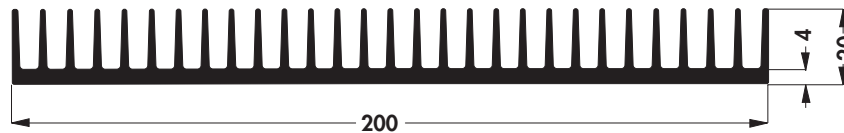
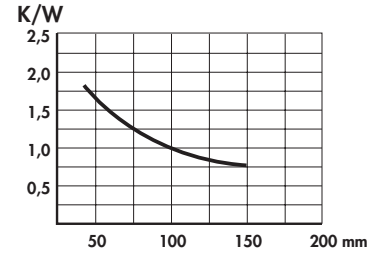

SK 113

↔ 50 75 100 150 1000 mm

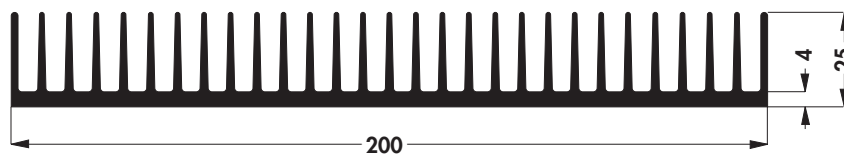
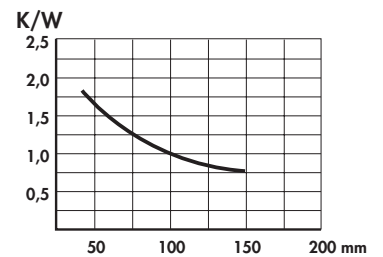

SK 42

↔ 50 75 100 150 200 1000 mm

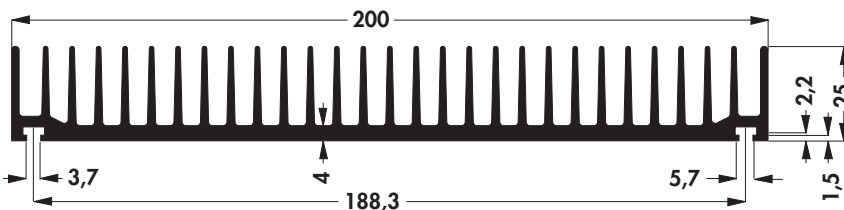
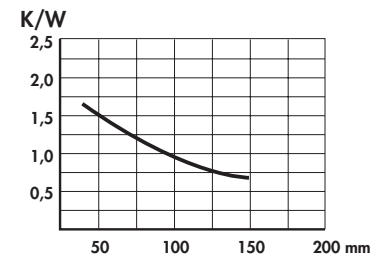

SK 94

↔ 75 1000 mm

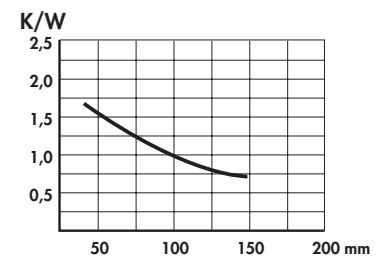

Strangkühlkörper	Extruded heatsinks	Dissipateurs extrudés
------------------	--------------------	-----------------------

SK 71

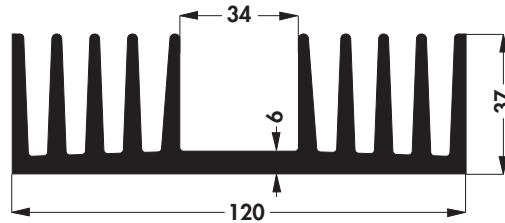

↔ 37,5 50 75 100 1000 mm

⊙ TO 3

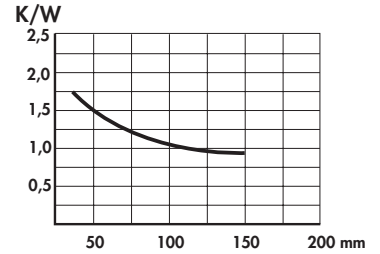

SK 197

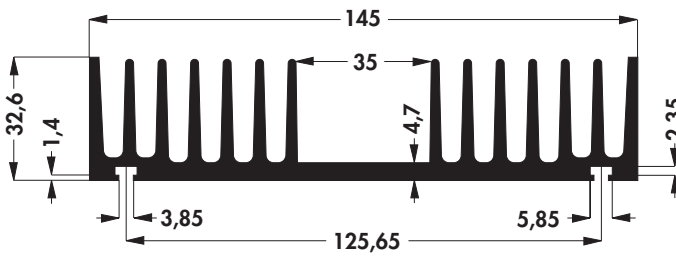

↔ 37,5 1000 mm

⊙ TO 3 ⊙ CB

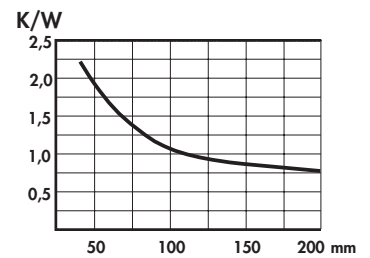

SK 98

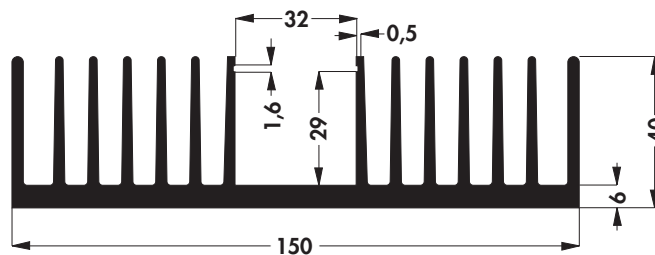

↔ 100 150 1000 mm

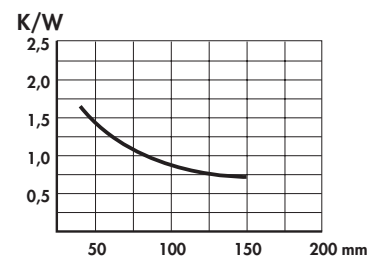

Strangkühlkörper

Extruded heatsinks

Dissipateurs extrudés

SK 02

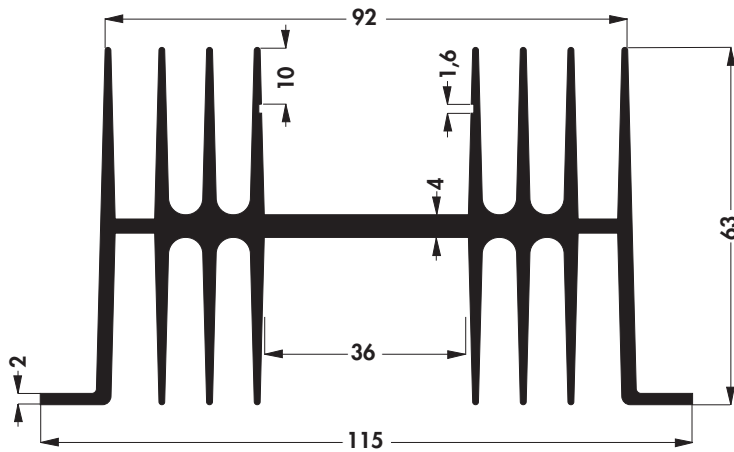

┆ 37,5 50 75 100 1000 mm

⌀ TO 3 ⌀ CB

mit Führungsnuten für Abdeckplatten oder Platinen with slots for cover plates or P.C.B.'s. avec rainures pour tôles de protection ou cartes imprimées.

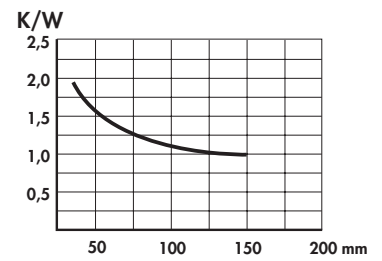

Strangkühlkörper

Extruded heatsinks

Dissipateurs extrudés

SK 34

↔ 50 75 100 1000 mm

⊙ TO 3 ⊙ CB

mit Führungsnuten für Abdeckplatten oder Platinen

with slots for cover plates or P.C.B.'s.

avec rainures pour tôles de protection ou cartes imprimées.

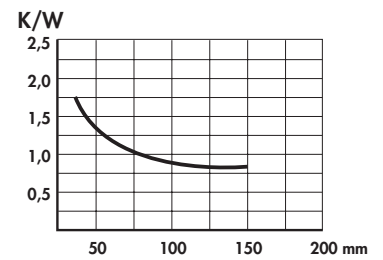
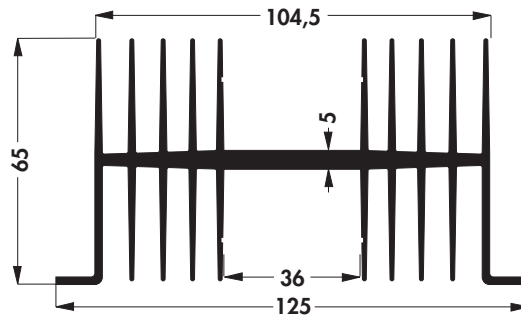

Strangkühlkörper

Extruded heatsinks

Dissipateurs extrudés

SK 148

37,5 100 1000 mm

TO 3 CB

mit Führungsnuten für Abdeckplatten oder Platinen

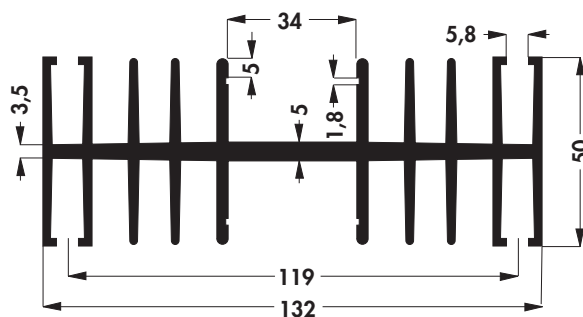

with slots for cover plates or P.C.B.'s.

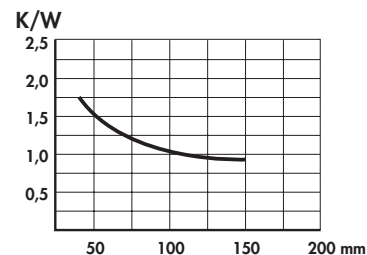

avec rainures pour tôles de protection ou cartes imprimées.

Strangkühlkörper

Extruded heatsinks

Dissipateurs extrudés

SK 67

37,5 50 100 1000 mm

TO 3

Montageteil IS 6 → E 26

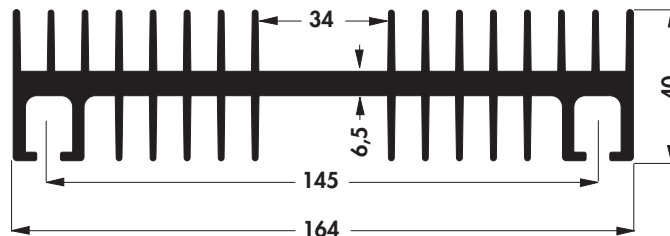

Mounting part IS 6 → E 26

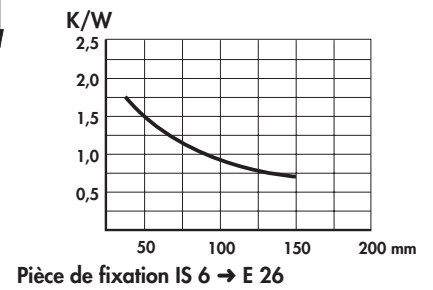

Pièce de fixation IS 6 → E 26

SK 137

1000 mm

TO 3 CB

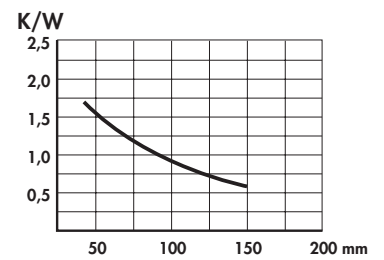
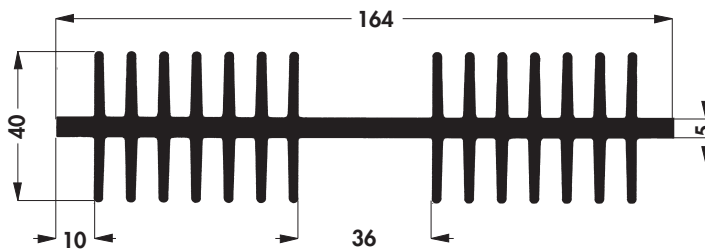

SK 43

1000 mm

TO 3 CB

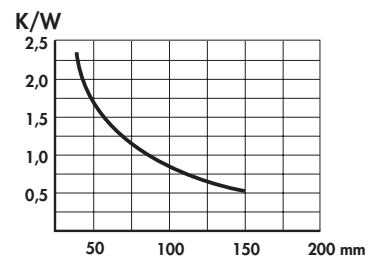
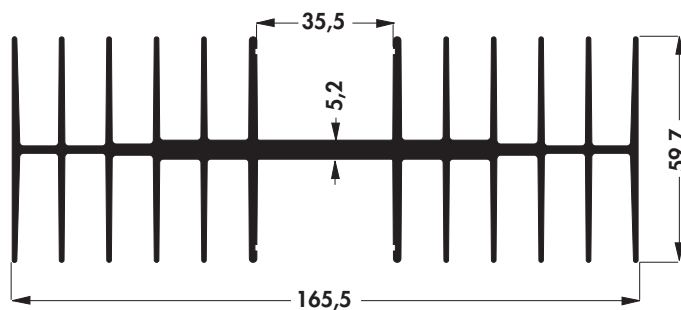

Strangkühlkörper

Extruded heatsinks

Dissipateurs extrudés

SK 88

37,5 50 75 100 1000 mm

TO 3

mit Führungsnuten für Abdeckplatten oder Platinen

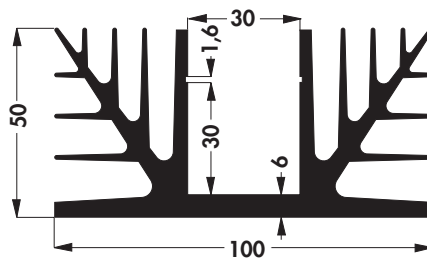

with slots for cover plates or P.C.B.'s.

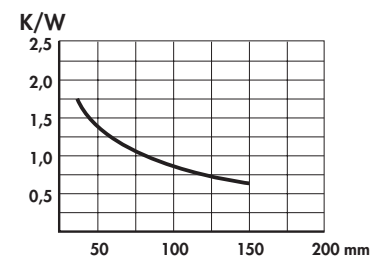

avec rainures pour tôles de protection ou cartes imprimées

Strangkühlkörper

Extruded heatsinks

Dissipateurs extrudés

SK 147

┆ 50 75 150 1000 mm

⊙ 2 x TO 3 ⊙ 2 x CB

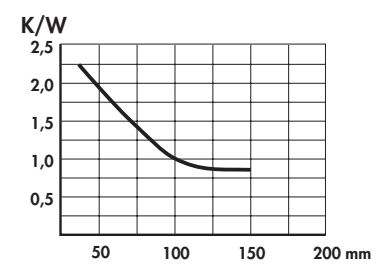
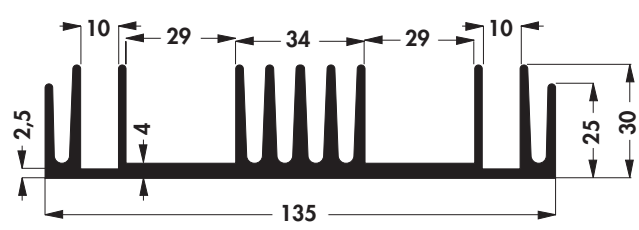

SK 80

┆ 75 100 1000 mm

⊙ 2 x TO 3 ⊙ 2 x CB

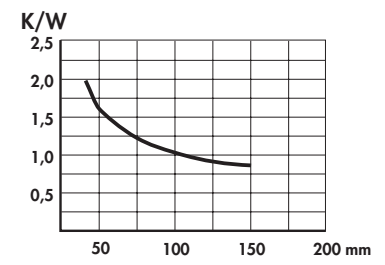
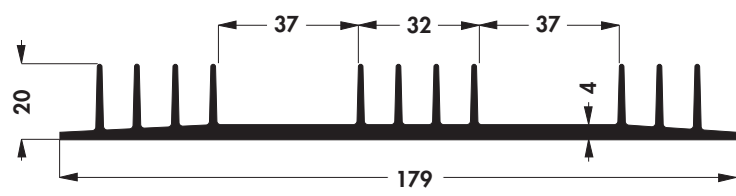

Strangkühlkörper	Extruded heatsinks	Dissipateurs extrudés
------------------	--------------------	-----------------------

SK 140

1000 mm

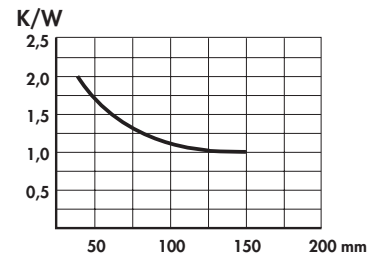
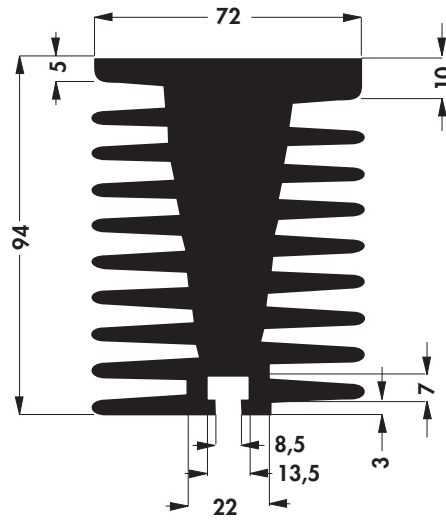

SK 89

100 150 1000 mm

SSR 1 SSR 2

mit Führungsnuten für Abdeckplatten oder Platinen

with slots for cover plates or P.C.B.'s

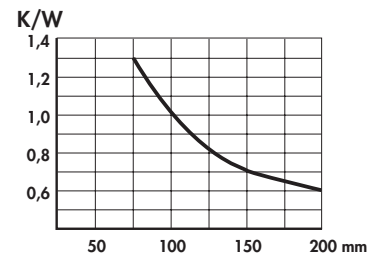
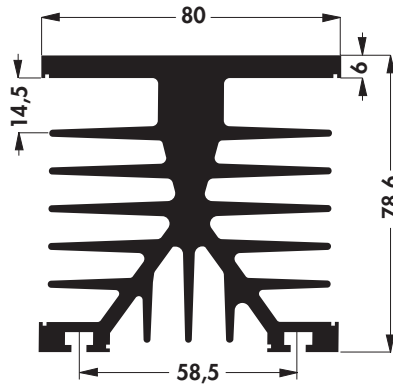

avec rainures pour tôles de protection ou cartes imprimées

Strangkühlkörper

Extruded heatsinks

Dissipateurs extrudés

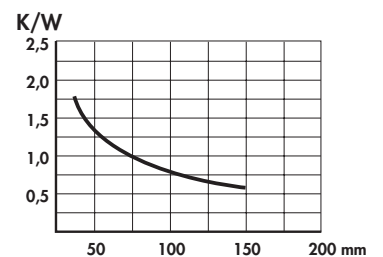
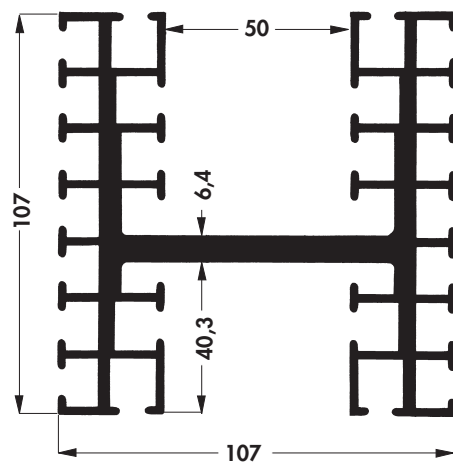

SK 06

↔ 75 100 150 1000 mm

⌀ TO 3

Montageteil IS 4 → E 26

Mounting part IS 4 → E 26

Pièce de fixation IS 4 → E 26

Strangkühlkörper

Extruded heatsinks

Dissipateurs extrudés

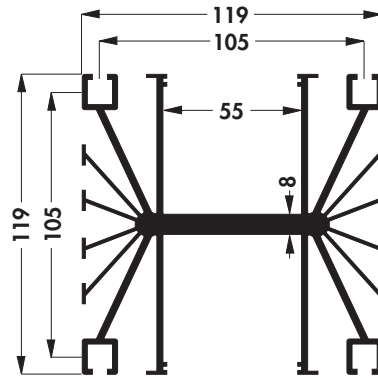

SK 23

↔ 75 100 150 1000 mm

mit Lüfter und Endplatten versehen = LA 4
→ D 13

Equipped with fan and endplates = LA 4
→ D 13

Monté avec ventilateur et flasques = LA 4
→ D 13

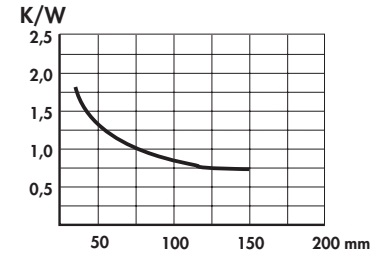

Spezialkühlkörper

Special heatsinks

Dissipateurs spéciaux

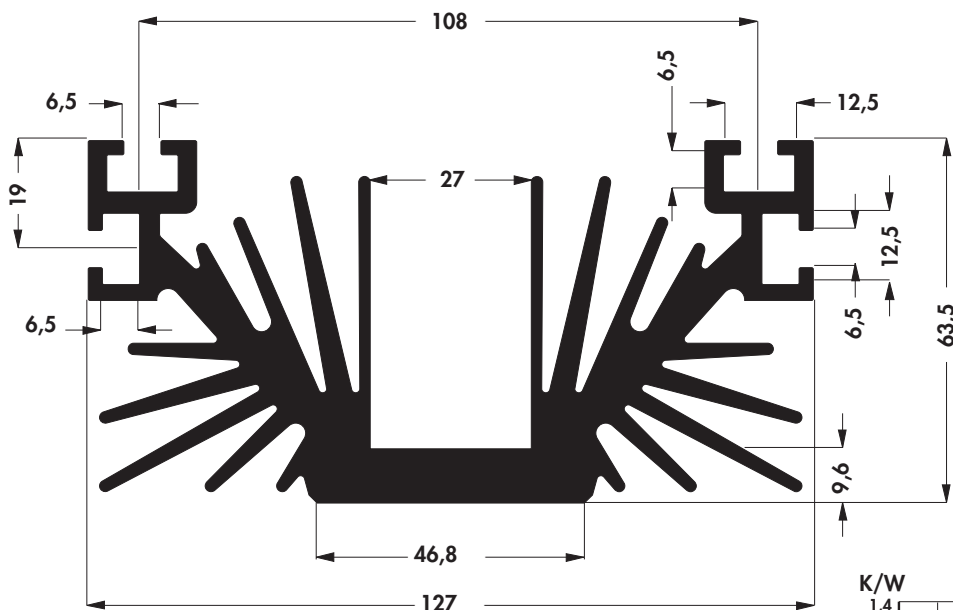

SK 40

 100 1000 mm

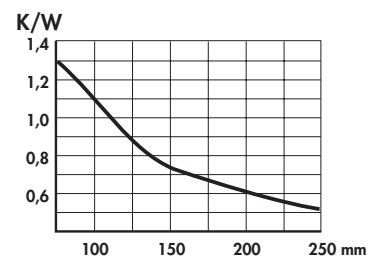

Spezialkühlkörper

Special heatsinks

Dissipateurs spéciaux

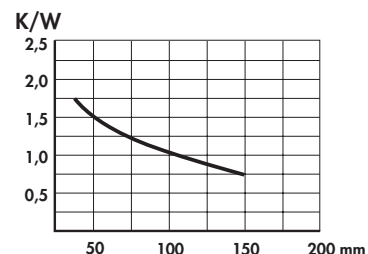
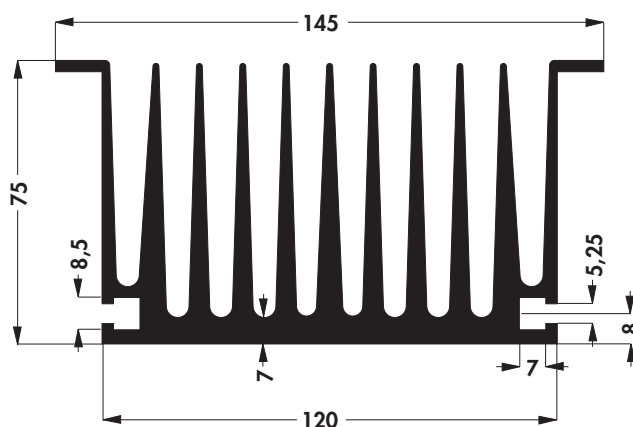

SK 194

50 75 100 1000 mm

SSR 2

Strangkühlkörper

Extruded heatsinks

Dissipateurs extrudés

SK 61

75 100 150 1000 mm

Wärmeableitgehäuse → M 29

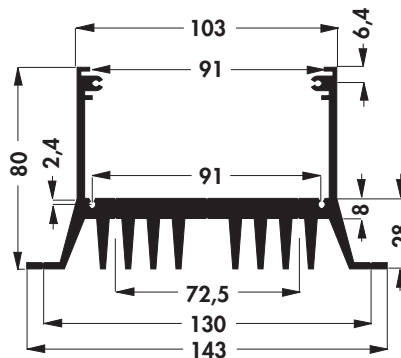

Cooling case → M 29

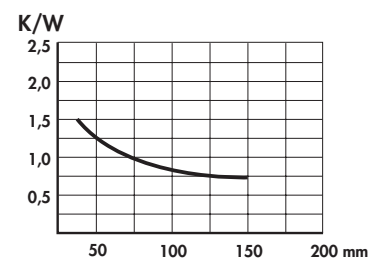

Caisson de réfrigération → M 29

Strangkühlkörper

Extruded heatsinks

Dissipateurs extrudés

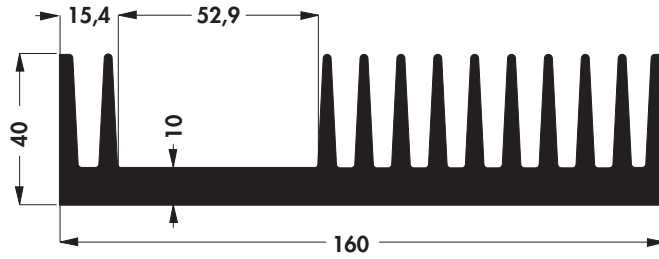

SK 404

50 75 1000 mm

TO 3 CB

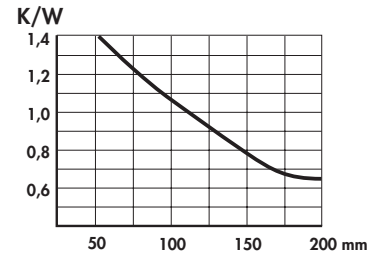

Leiterplattenkühlkörper

PCB heatsinks

Dissipateurs de chaleur sur platine

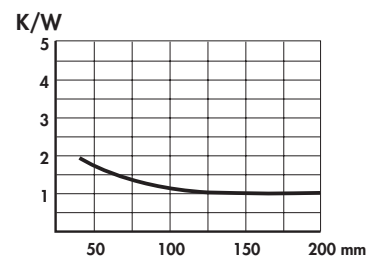

SK 415

↔ 37,5 50 100 150 200 1000 mm