

Strangkühlkörper

Extruded heatsinks

Dissipateurs extrudés

SK 466

50 75 100 150 1000 mm

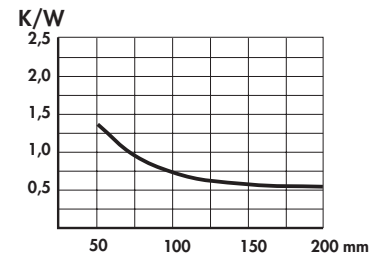
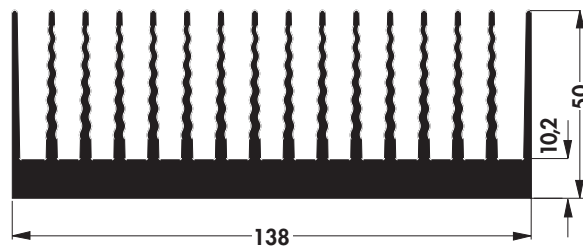

Strangkühlkörper

Extruded heatsinks

Dissipateurs extrudés

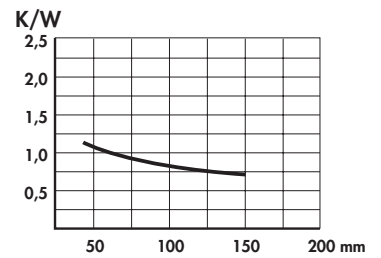
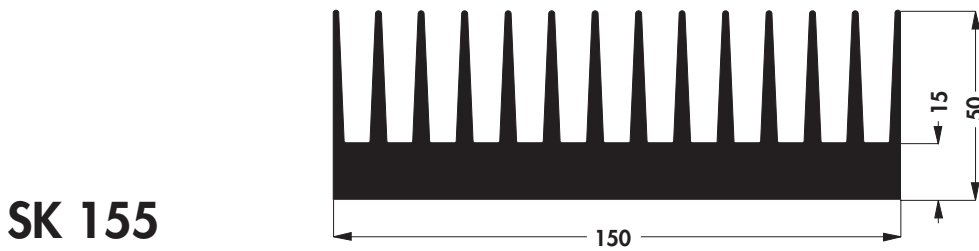

SK 155

↔ 75 100 150 1000 mm

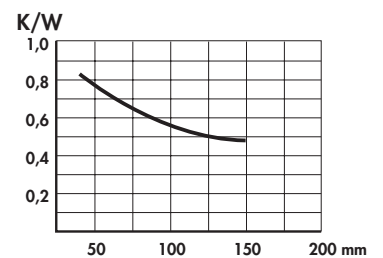
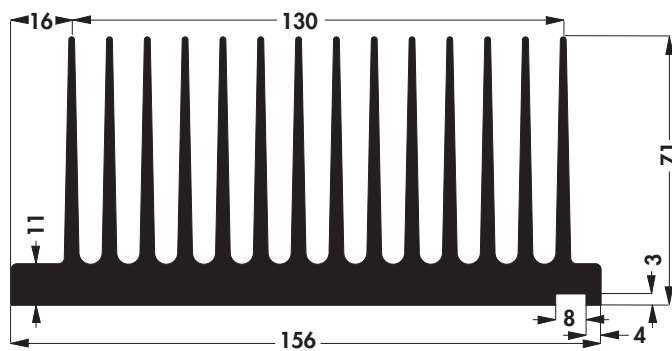

SK 154

↔ 50 75 100 150 1000 mm

Strangkühlkörper

Extruded heatsinks

Dissipateurs extrudés



SK 416

50 75 100 150 1000 mm

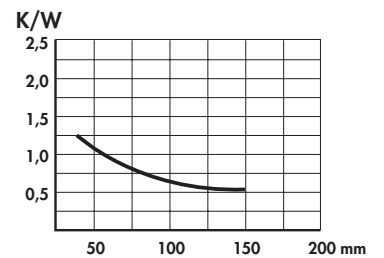
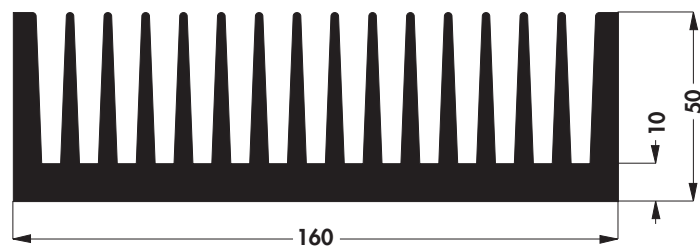

Strangkühlkörper	Extruded heatsinks	Dissipateurs extrudés
------------------	--------------------	-----------------------

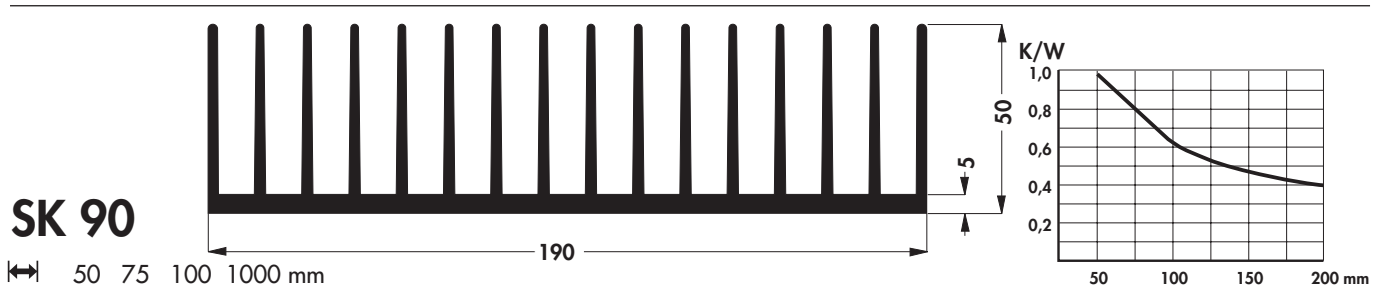
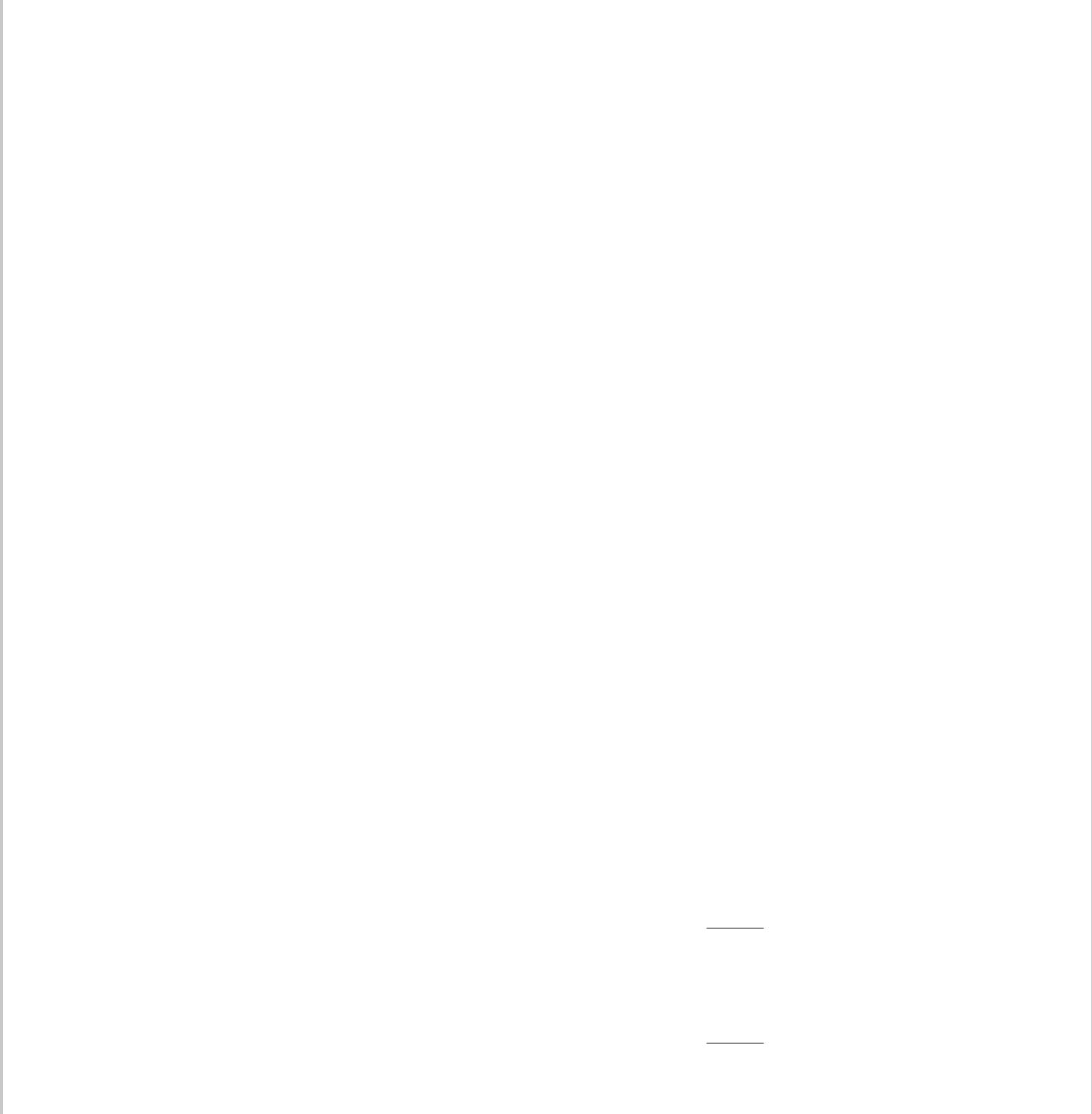

Strangkühlkörper

Extruded heatsinks

Dissipateurs extrudés

SK 47

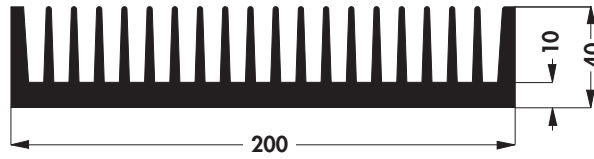

↔ 75 100 150 1000 mm

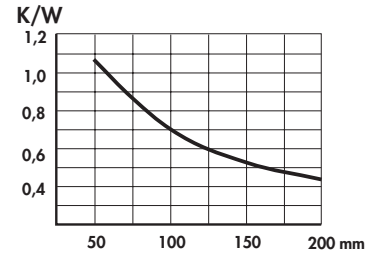

SK 193

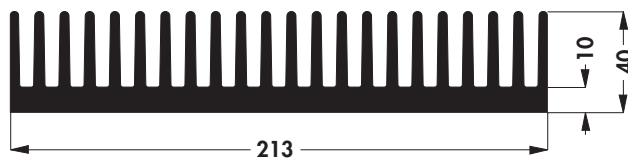

↔ 100 150 1000 mm

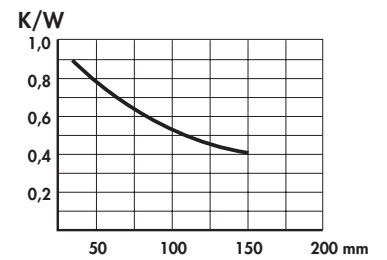

SK 102

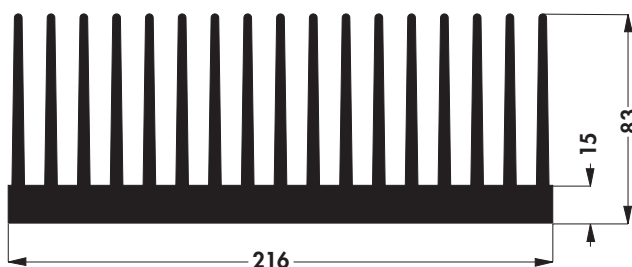

↔ 75 100 150 1000 mm

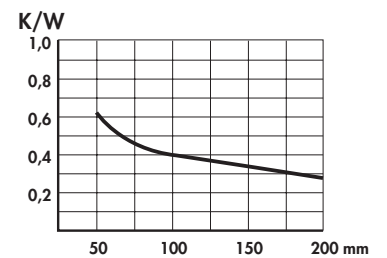

Strangkühlkörper

Extruded heatsinks

Dissipateurs extrudés

SK 168

1000 mm

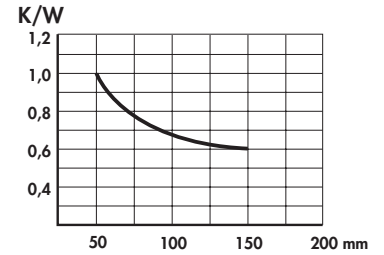
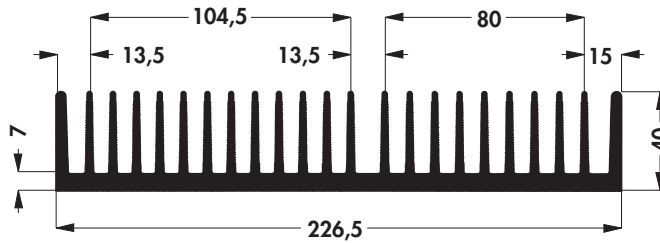

SK 118

75 100 150 1000 mm

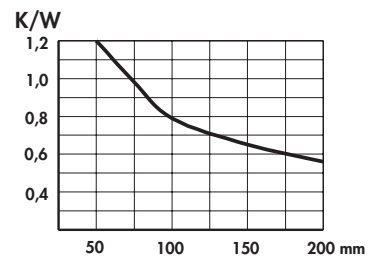
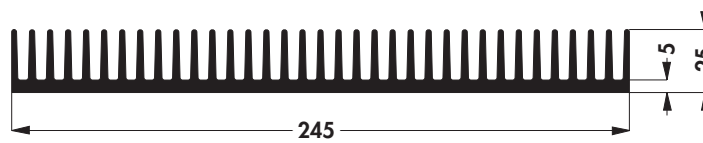

SK 49

50 75 150 200 1000 mm

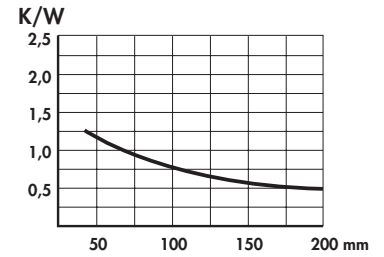
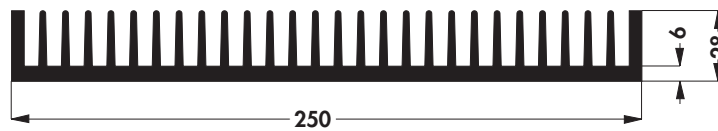

SK 199

75 100 1000 mm

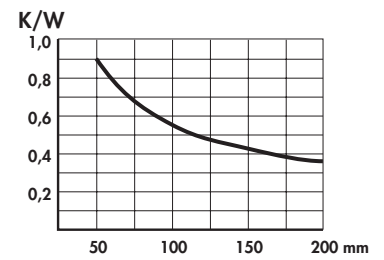
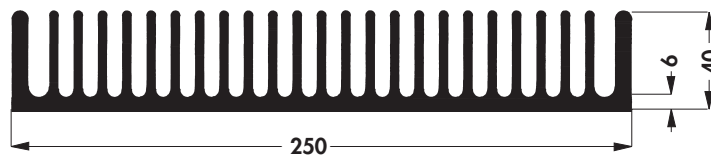

SK 91

75 100 150 1000 mm

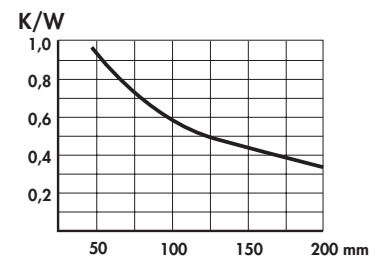
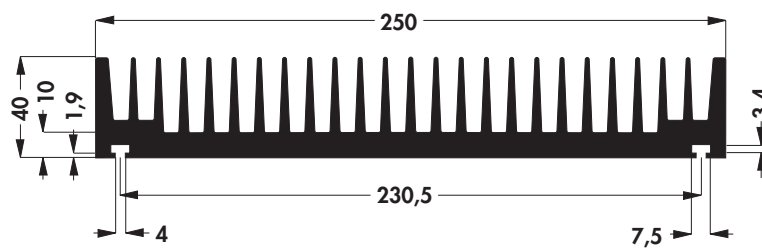

Strangkühlkörper

Extruded heatsinks

Dissipateurs extrudés

SK 438

↔ 75 100 150 1000 mm

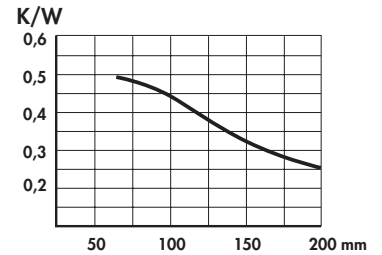
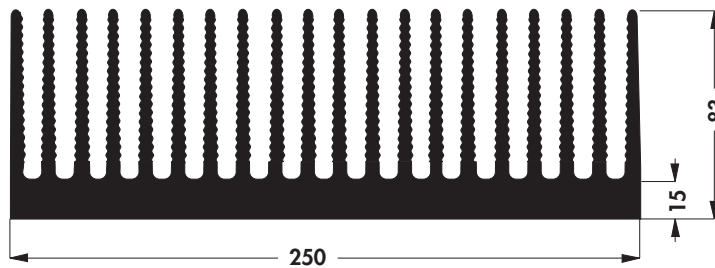

SK 190

↔ 150 1000 mm

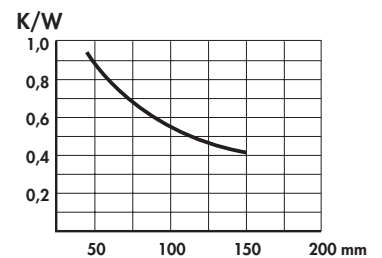
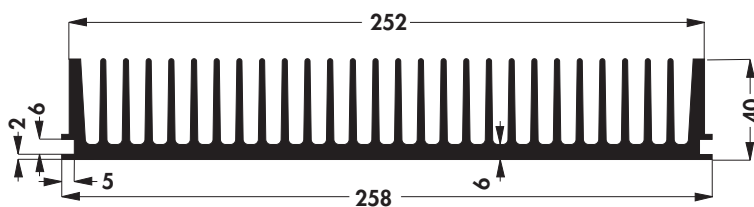

SK 149

↔ 150 200 1000 mm

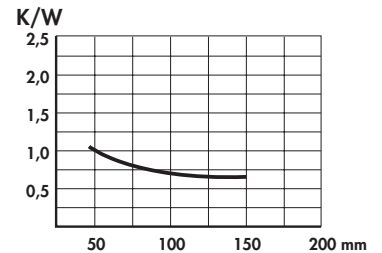
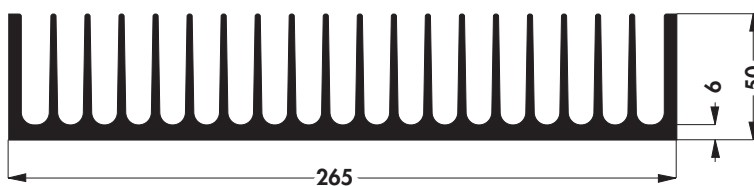

SK 139

↔ 100 150 200 1000 mm

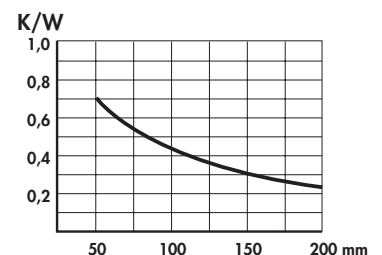
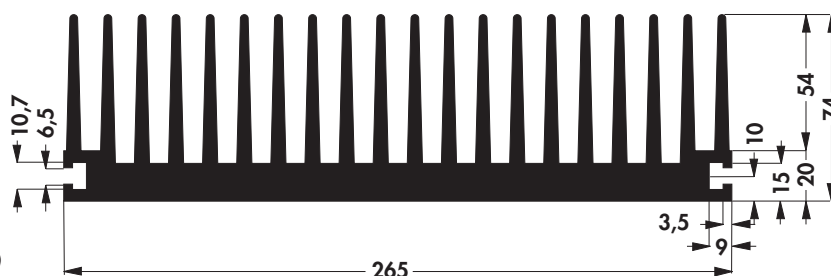

SK 198

↔ 75 100 150 1000 mm

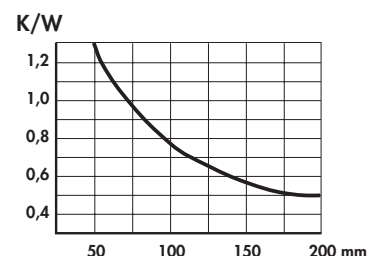
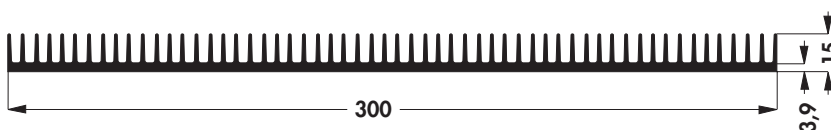

Strangkühlkörper

Extruded heatsinks

Dissipateurs extrudés

SK 446

75 100 150 1000 mm

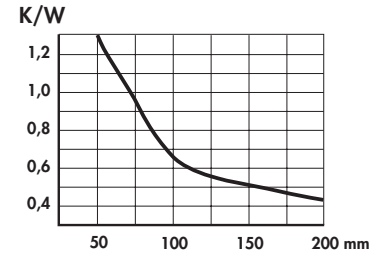
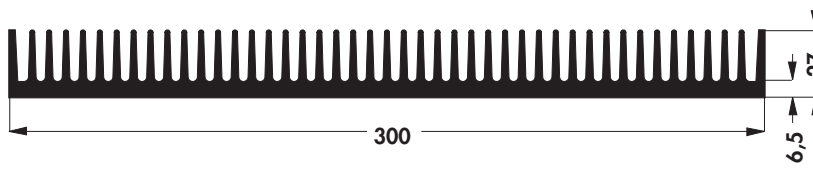

SK 56

75 100 150 200 1000 mm

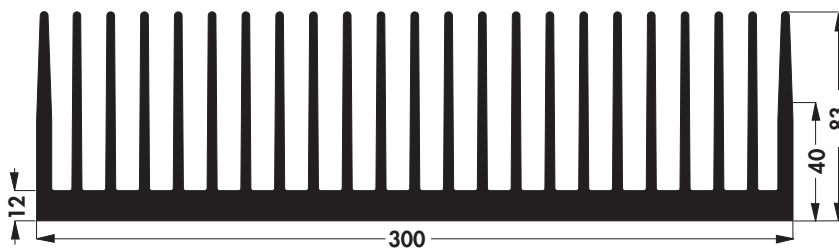
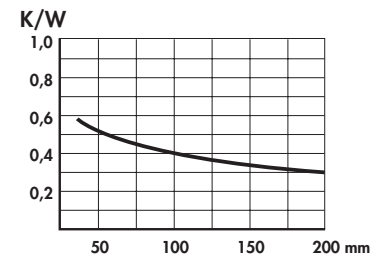
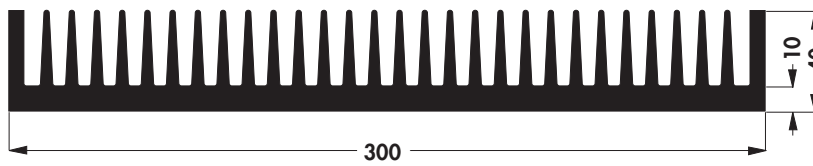

SK 157

100 150 200 1000 mm

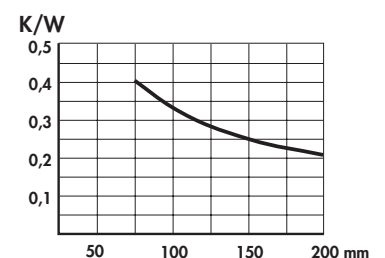

Strangkühlkörper

Extruded heatsinks

Dissipateurs extrudés

SK 101

75 100 1000 mm

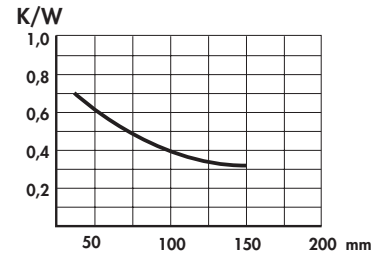
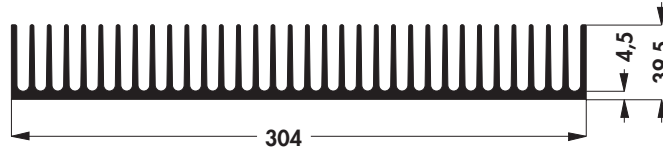

SK 439

100 150 1000 mm

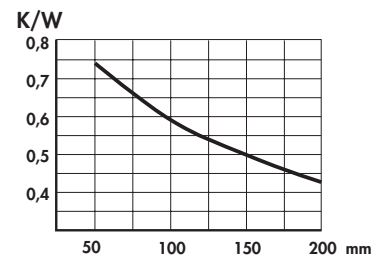
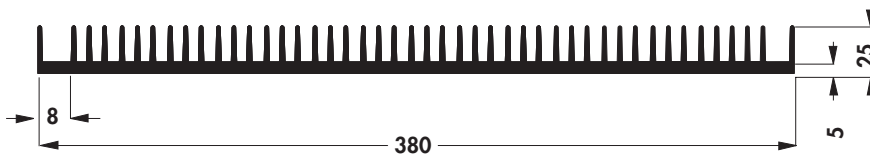

SK 93

75 100 150 1000 mm

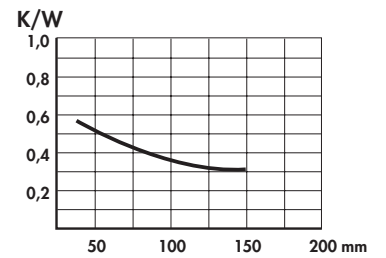
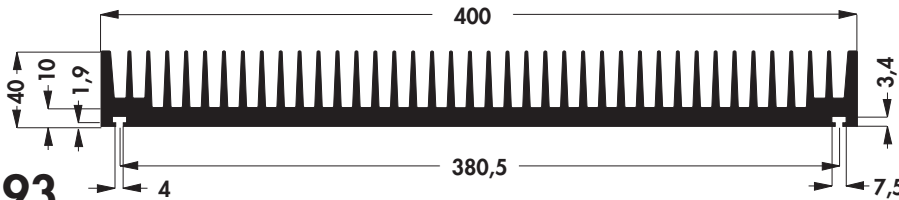

SK 479

75 100 150 1000 mm

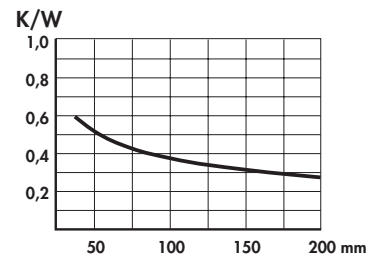
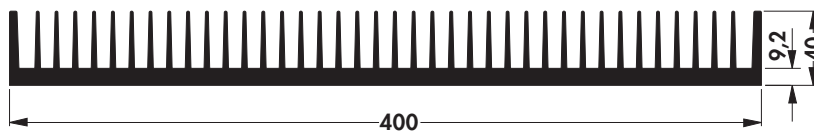

SK 130

100 200 1000 mm

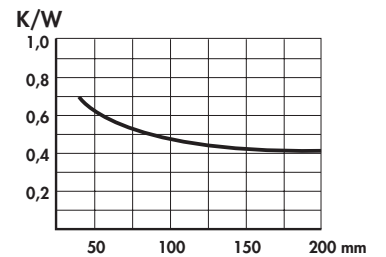
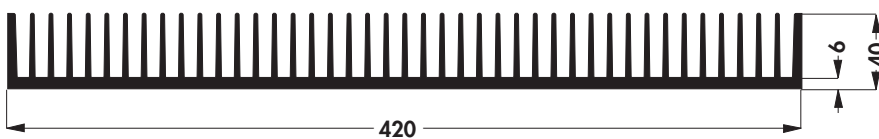

SK 191

75 100 150 200 1000 mm

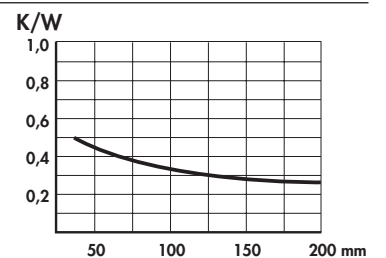
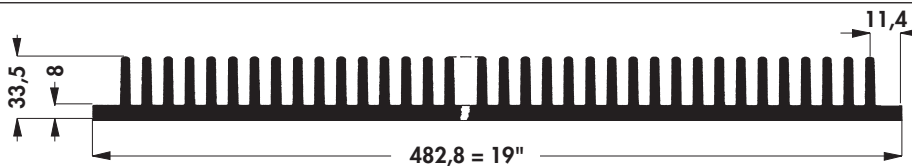

Als Rückwandkühlkörper für 19" Gehäuse geeignet.

Suitable heatsink for rear panel in 19" case.

Dissipateur convenable comme face arrière de boîtier 19"

Strangkühlkörper

Extruded heatsinks

Dissipateurs extrudés

Hochleistungs-Kühlkörper mit eingepressten Rippen

High-Performance Heatsinks with pressed-in fins

Dissipateurs de grand rendement avec des ailettes serrées

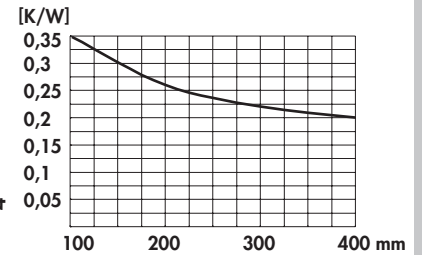
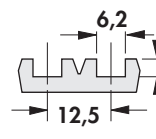
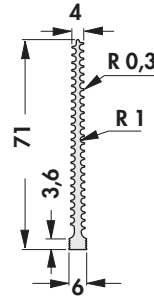
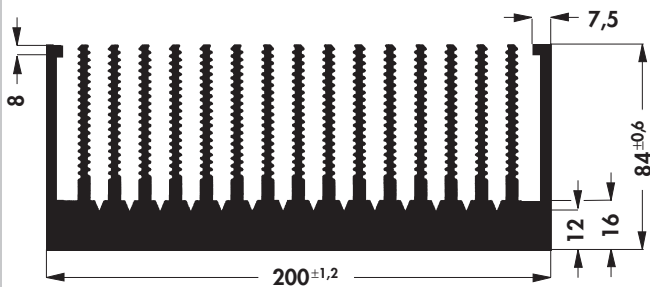

SK 418

100 150 200 1000 mm

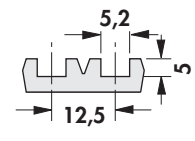
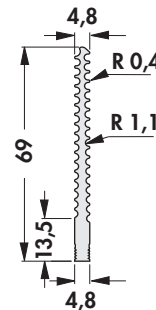
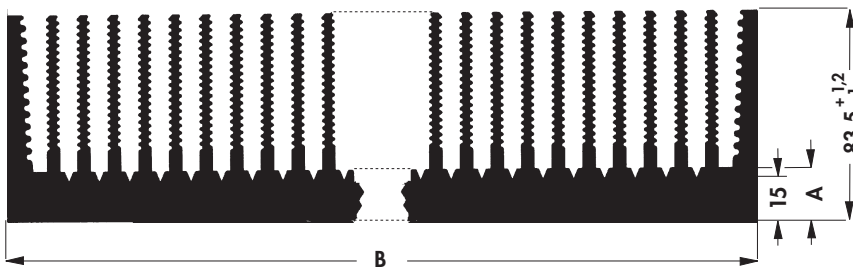

Art. Nr. Art. No. Art. n°	Rippenanzahl No. of fins N° d'ailettes	A	B
SK 158	22	20	300±2
SK 159	30	20	400±2
SK 160	38	20	500±2,5
SK 161	46	20	600±3
SK 162	58	20	750±4

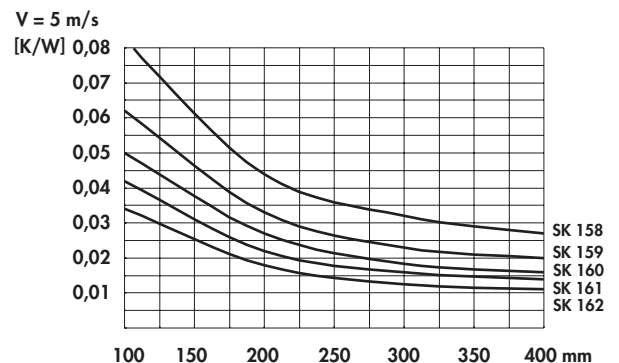
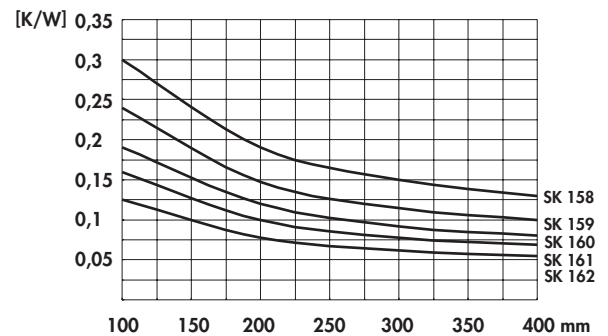

Strangkühlkörper

Extruded heatsinks

Dissipateurs extrudés

SK 57

↔ 37,5 75 100 1000 mm

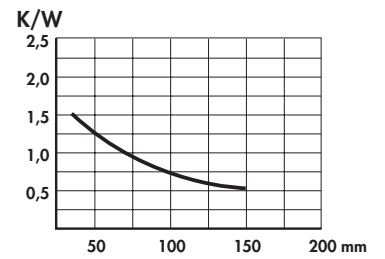
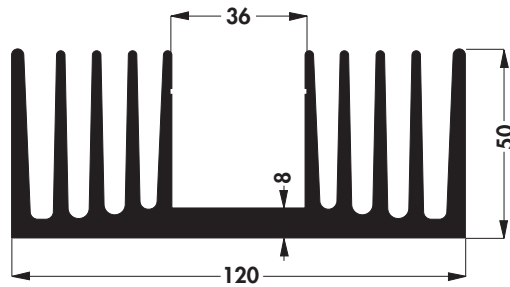

Strangkühlkörper

Extruded heatsinks

Dissipateurs extrudés

SK 30

↔ 75 100 1000 mm

⊙ TO 3 ⊙ CB

mit Führungsnuten für Abdeckplatten oder Platinen

with slots for cover plates or P.C.B.'s.

avec rainures pour tôles de protection ou cartes imprimées.

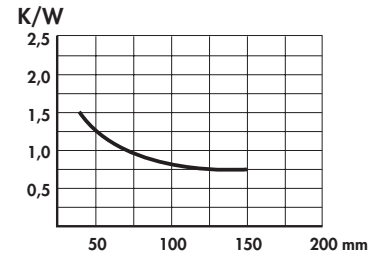
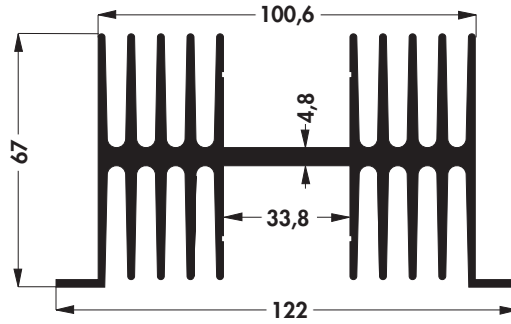

Strangkühlkörper

Extruded heatsinks

Dissipateurs extrudés

SK 10

50 100 mm

TO 3

mit Führungsnuten für Abdeckplatten oder Platinen

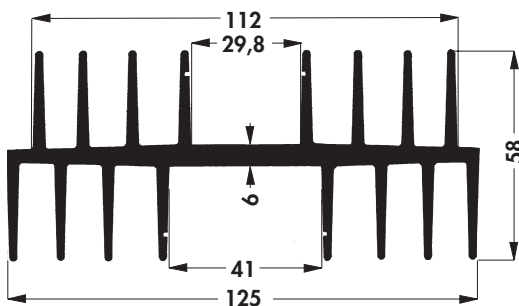

with slots for cover plates or P.C.B.'s.

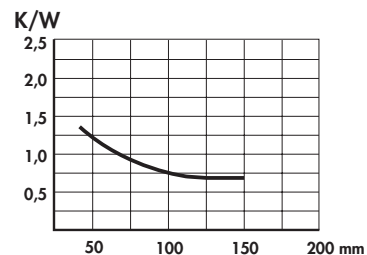

avec rainures pour tôles de protection ou cartes imprimées.

Strangkühlkörper

Extruded heatsinks

Dissipateurs extrudés

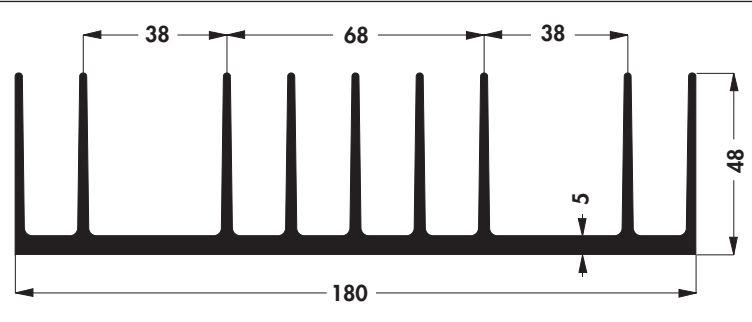

SK 53

50 75 100 150 1000 mm

2 x TO 3 2 x CB

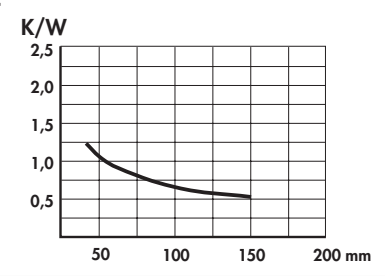

Strangkühlkörper

Extruded heatsinks

Dissipateurs extrudés

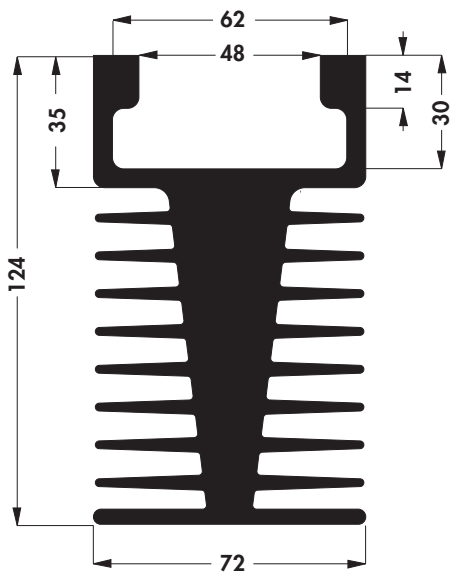
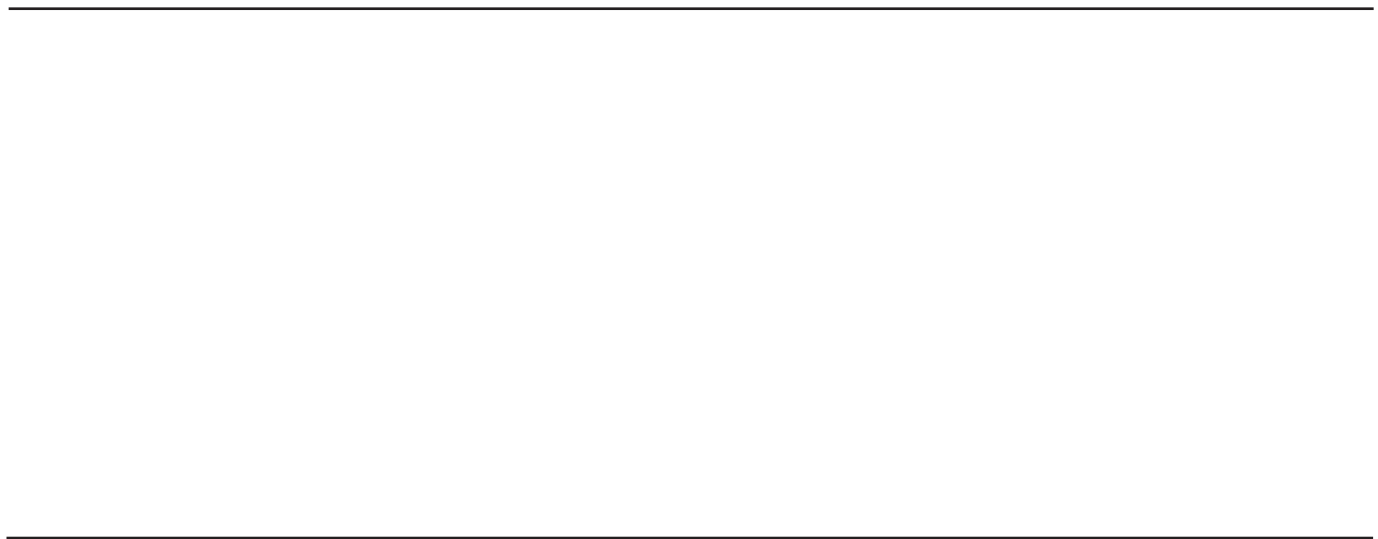

SK 15

↔ 75 1000 mm

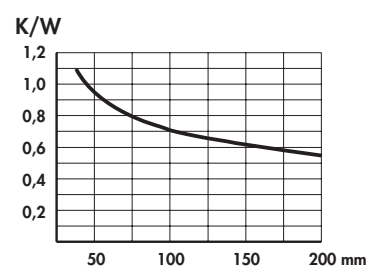

Strangkühlkörper

Extruded heatsinks

Dissipateurs extrudés

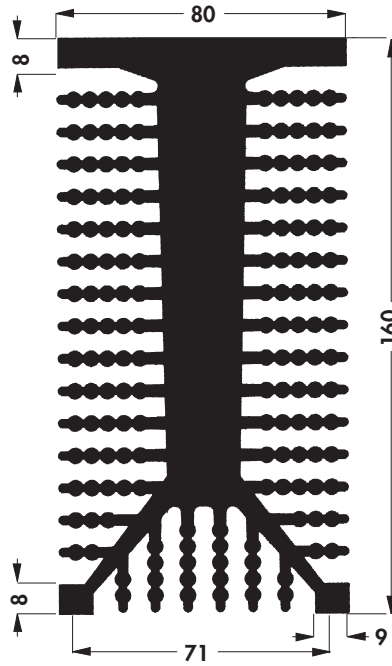

SK 163

↔ 100 150 1000 mm

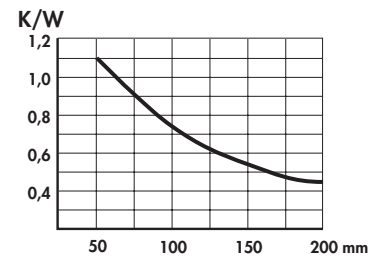

Strangkühlkörper

Extruded heatsinks

Dissipateurs extrudés

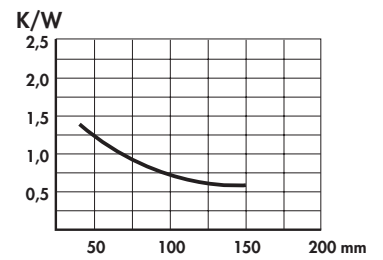
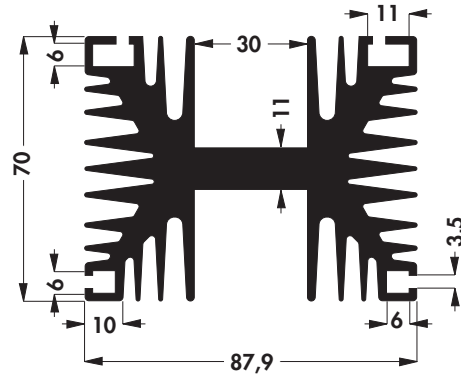

SK 83

↔ 100 1000 mm

Strangkühlkörper

Extruded heatsinks

Dissipateurs extrudés

SK 109

100 150 200 1000 mm

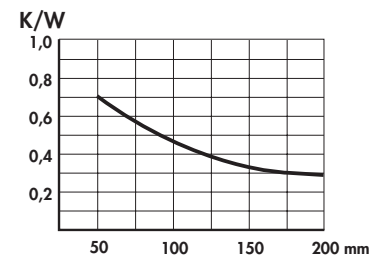
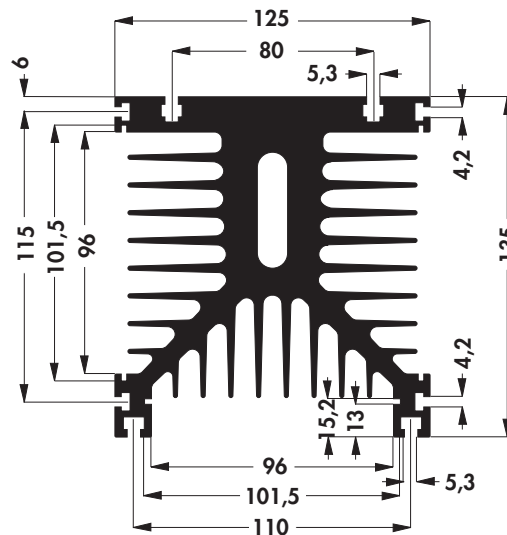

SK 108

100 150 1000 mm

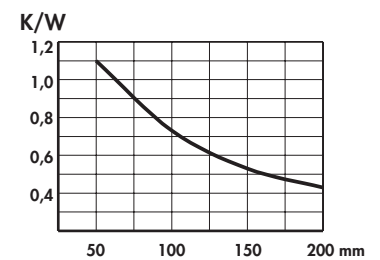
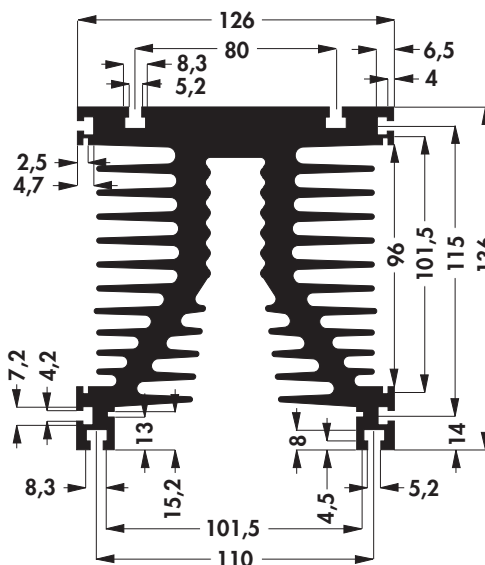

Strangkühlkörper

Extruded heatsinks

Dissipateurs extrudés

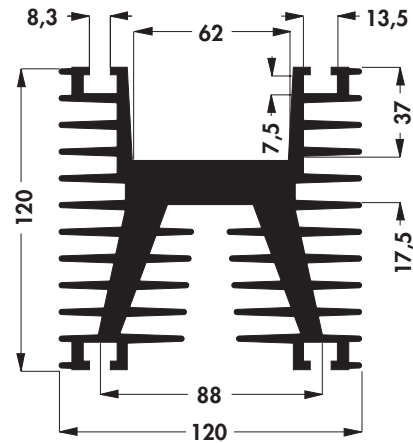

SK 141

75 100 150 200 1000 mm

SSR 1

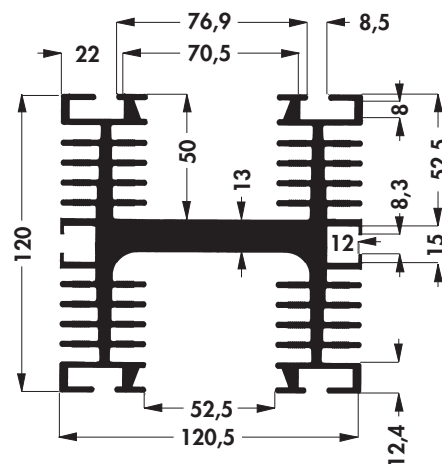
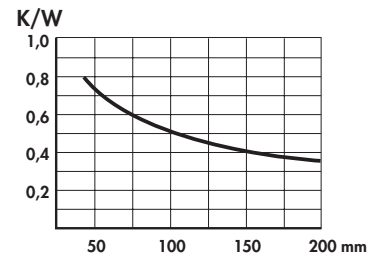

SK 110

75 100 150 200 1000 mm

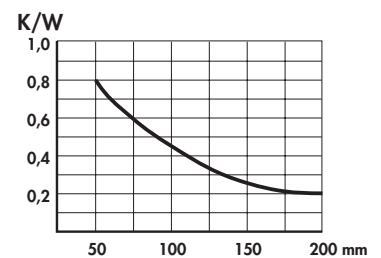

Spezialkühlkörper

Special heatsinks

Dissipateurs spéciaux

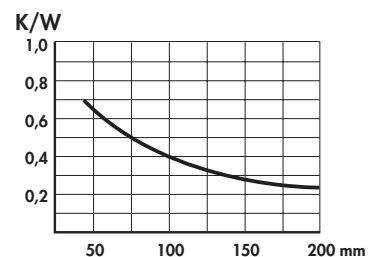
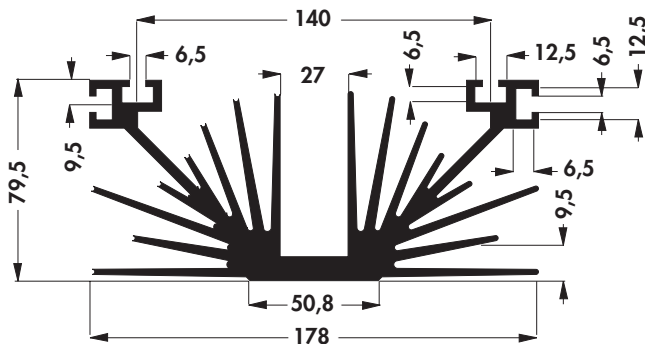

SK 41

75 100 150 1000 mm

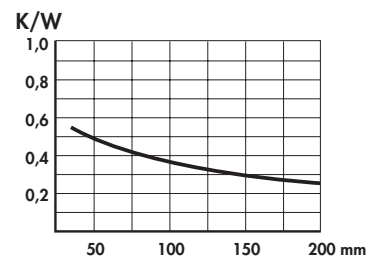
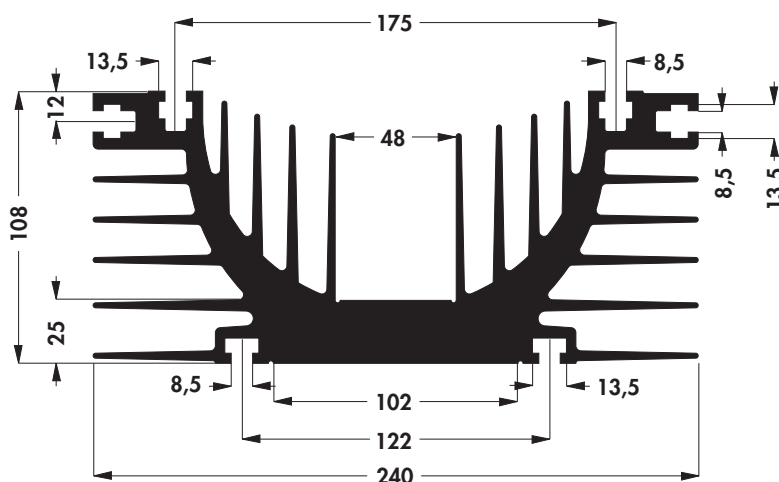

SK 144

1000 mm

Spezialkühlkörper

Special heatsinks

Dissipateurs spéciaux

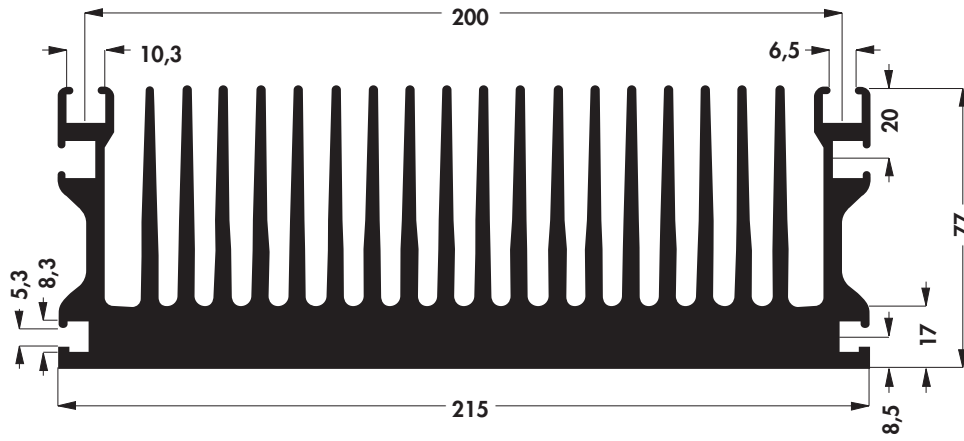

SK 435

150 200 1000 mm

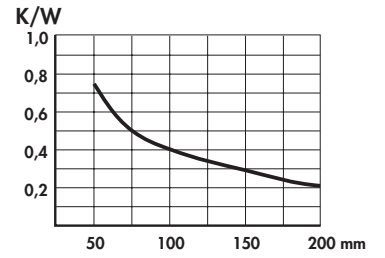

Strangkühlkörper

Extruded heatsinks

Dissipateurs extrudés

SK 86

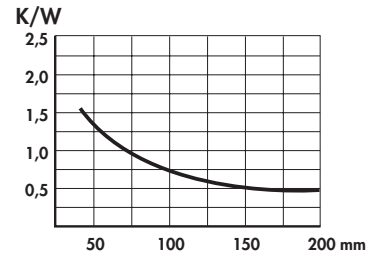
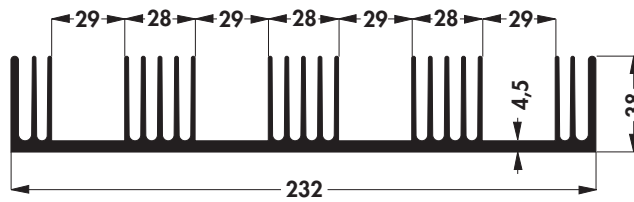

75 100 150 1000 mm

SK 66

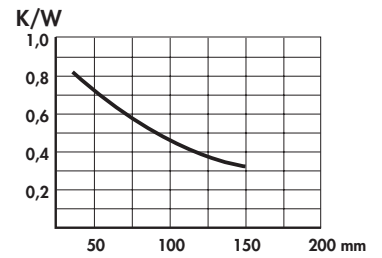
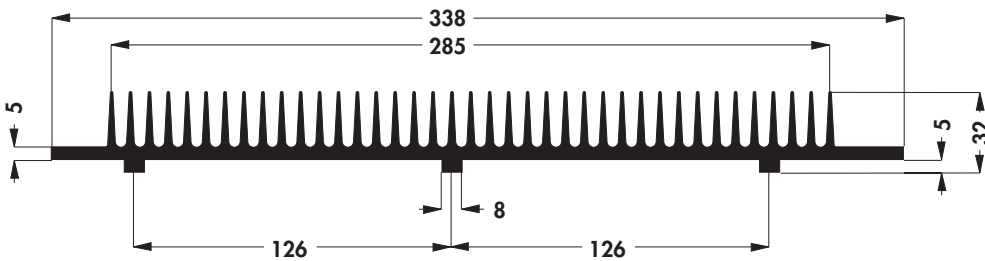

75 100 1000 mm

SK 82

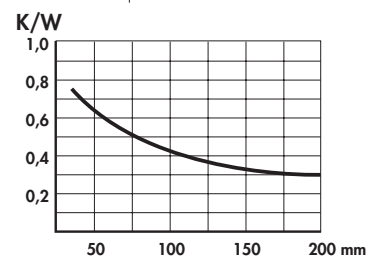
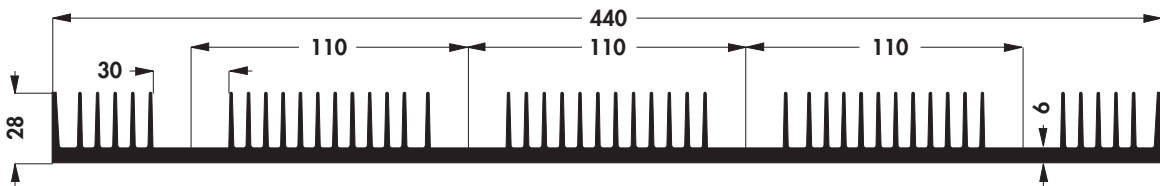

100 1000 mm

SK 127

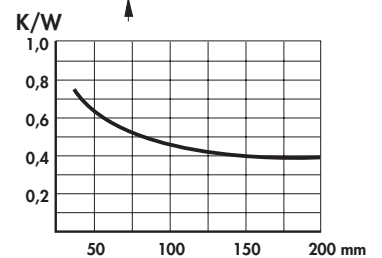
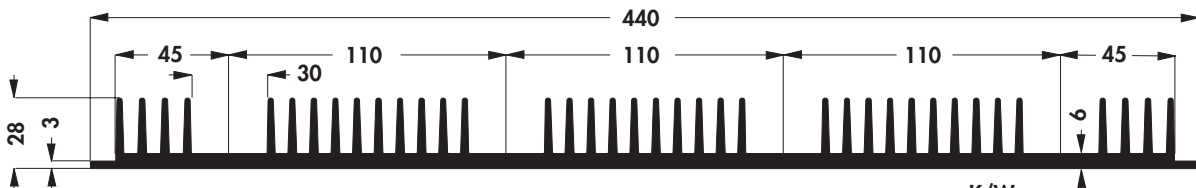

75 1000 mm

Besonders geeignet als Rückwandprofil für 19" Gehäuse.

Especially suitable as rear panel profile for 19" cases.



Convient en particulier comme profilé de face arrière pour des boîtiers 19".

Strangkühlkörper

Extruded heatsinks



Dissipateurs extrudés

SK 33

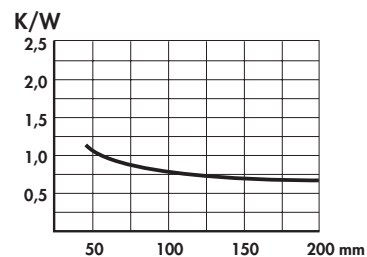
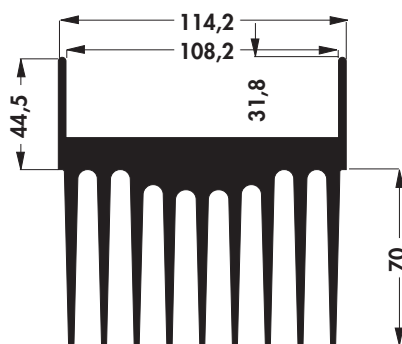
 50 100 1000 mm
 SSR 1  SSR 2



SK 70

 37,5 50 75 100 150 1000 mm
 TO 3  CB

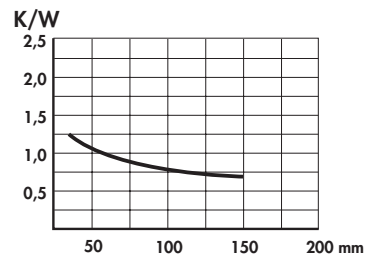
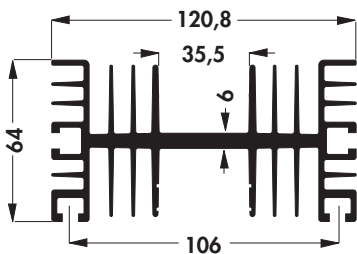

Passende Montageteile → E 26
 Montageteil IS 7 → E 26

Suitable mounting parts → E 26
 Mounting part IS 7 → E 26

Pièces de fixation convenantes → E 26
 Pièce de fixation IS 7 → E 26